

SECTION **BCS**

BODY CONTROL SYSTEM

A

B

C

D

E

CONTENTS

BASIC INSPECTION	REAR WINDOW DEFOGGER : CONSULT-III Function (BCM - REAR DEFOGGER)	F
INSPECTION AND ADJUSTMENT		
ADDITIONAL SERVICE WHEN REPLACING CONTROL UNIT	BUZZER	G
ADDITIONAL SERVICE WHEN REPLACING CONTROL UNIT : Description	BUZZER : CONSULT-III Function (BCM - BUZZ- ER)	17
ADDITIONAL SERVICE WHEN REPLACING CONTROL UNIT : Special Repair Requirement		
SYSTEM DESCRIPTION	INT LAMP	H
BODY CONTROL SYSTEM	INT LAMP : CONSULT-III Function (BCM - INT LAMP)	18
System Description		
Component Parts Location	HEADLAMP	I
COMBINATION SWITCH READING SYSTEM	HEADLAMP : CONSULT-III Function (BCM - HEAD LAMP)	19
System Diagram		
System Description	WIPER	J
SIGNAL BUFFER SYSTEM	WIPER : CONSULT-III Function (BCM - WIPER)...21	
System Diagram		
System Description	FLASHER	K
POWER CONSUMPTION CONTROL SYS- TEM	FLASHER : CONSULT-III Function (BCM - FLASHER)	22
System Diagram		
System Description	INTELLIGENT KEY	L
Component Parts Location	INTELLIGENT KEY : CONSULT-III Function (BCM - INTELLIGENT KEY)	23
DIAGNOSIS SYSTEM (BCM)		
COMMON ITEM	COMB SW	N
COMMON ITEM : CONSULT-III Function (BCM - COMMON ITEM)	COMB SW : CONSULT-III Function (BCM - COMB SW)	26
DOOR LOCK		
DOOR LOCK : CONSULT-III Function (BCM - DOOR LOCK)	BCM	O
REAR WINDOW DEFOGGER	BCM : CONSULT-III Function (BCM - BCM)	27
	IMMU	P
	IMMU : CONSULT-III Function (BCM - IMMU)	27
	BATTERY SAVER	28
	BATTERY SAVER : CONSULT-III Function (BCM - BATTERY SAVER)	28
	TRUNK	29
	TRUNK : CONSULT-III Function (BCM - TRUNK)...29	
	THEFT ALM	29

F

G

H

I

J

K

L

BCS

N

O

P

THEFT ALM : CONSULT-III Function (BCM - THEFT)	29	COMBINATION SWITCH INPUT CIRCUIT	38
		Diagnosis Procedure	38
RETAINED PWR	30	COMBINATION SWITCH OUTPUT CIRCUIT ...	40
RETAINED PWR : CONSULT-III Function (BCM - RETAINED PWR)	30	Diagnosis Procedure	40
SIGNAL BUFFER	31	ECU DIAGNOSIS INFORMATION	42
SIGNAL BUFFER : CONSULT-III Function (BCM - SIGNAL BUFFER)	31	BCM (BODY CONTROL MODULE)	42
AIR PRESSURE MONITOR	31	Reference Value	42
AIR PRESSURE MONITOR : CONSULT-III Function (BCM - AIR PRESSURE MONITOR)	31	Wiring Diagram - BCM -	65
		Fail-safe	70
DTC/CIRCUIT DIAGNOSIS	33	DTC Inspection Priority Chart	72
		DTC Index	73
U1000 CAN COMM	33	SYMPTOM DIAGNOSIS	76
Description	33	COMBINATION SWITCH SYSTEM SYMPTOMS	76
DTC Logic	33	Symptom Table	76
Diagnosis Procedure	33	PRECAUTION	77
U1010 CONTROL UNIT (CAN)	34	PRECAUTIONS	77
DTC Logic	34	Precaution for Supplemental Restraint System (SRS) "AIR BAG" and "SEAT BELT PRE-TENSIONER"	77
Diagnosis Procedure	34	Precaution for Battery Service	77
U0415 VEHICLE SPEED	35	REMOVAL AND INSTALLATION	78
Description	35	BCM (BODY CONTROL MODULE)	78
DTC Logic	35	Exploded View	78
Diagnosis Procedure	35	Removal and Installation	78
B2562 LOW VOLTAGE	36	COMBINATION SWITCH	79
DTC Logic	36	Exploded View	79
Diagnosis Procedure	36	Removal and Installation	79
POWER SUPPLY AND GROUND CIRCUIT	37		
Diagnosis Procedure	37		

INSPECTION AND ADJUSTMENT

< BASIC INSPECTION >

BASIC INSPECTION

INSPECTION AND ADJUSTMENT

ADDITIONAL SERVICE WHEN REPLACING CONTROL UNIT

ADDITIONAL SERVICE WHEN REPLACING CONTROL UNIT : Description

INFOID:000000005656175

Perform the system initialization when replacing BCM, replacing Intelligent Key or registering an additional Intelligent Key.

ADDITIONAL SERVICE WHEN REPLACING CONTROL UNIT : Special Repair Requirement

INFOID:000000005656176

Refer to the CONSULT-III operation manual for the initialization procedure.

A
B
C
D
E
F
G
H
I
J
K
L
N
O
P

BCS

BODY CONTROL SYSTEM

< SYSTEM DESCRIPTION >

SYSTEM DESCRIPTION

BODY CONTROL SYSTEM

System Description

INFOID:000000005656177

OUTLINE

- BCM (Body Control Module) controls the various electrical components. It inputs the information required to the control from CAN communication and the signal received from each switch and sensor.
- BCM has combination switch reading function for reading the operation status of combination switches (light, turn signal, wiper and washer) in addition to a function for controlling the operation of various electrical components. It also has the signal transmission function as the passed point of signal and the power saving control function that reduces the power consumption with the ignition switch OFF.
- BCM is equipped with the diagnosis function that performs the diagnosis with CONSULT-III and various settings.

BCM control function list

System	Refer to
Combination switch reading system	BCS-6, "System Diagram"
Signal buffer system	BCS-10, "System Diagram"
Power consumption control system	BCS-11, "System Diagram"
Auto light system	EXL-11, "System Diagram"
Turn signal and hazard warning lamp system	EXL-19, "System Diagram"
Headlamp system	EXL-7, "System Diagram"
Parking, license plate and tail lamps system	EXL-21, "System Diagram"
Front fog lamp system	EXL-17, "System Diagram"
Exterior lamp battery saver system	EXL-24, "System Diagram"
Daytime running light system	EXL-14, "System Diagram"
Interior room lamp control system	INL-5, "System Diagram"
Step lamp system	
Trunk room lamp system	
Interior room lamp battery saver system	INL-9, "System Diagram"
Front wiper and washer system	<ul style="list-style-type: none"> • WW-8, "FRONT WIPER AND WASHER SYSTEM (WITHOUT RAIN SENSOR) : System Diagram" (Without rain sensor) • WW-11, "FRONT WIPER AND WASHER SYSTEM (WITH RAIN SENSOR) : System Diagram" (With rain sensor)
Warning chime system	WCS-5, "WARNING CHIME SYSTEM : System Diagram"
Door lock system	DLK-11, "System Diagram"
Trunk open system	DLK-43, "System Diagram"
Infiniti Vehicle Immobilizer System (IVIS) - NATS	SEC-17, "System Diagram"
Vehicle security system	SEC-23, "System Diagram"
Panic alarm	DLK-28, "REMOTE KEYLESS ENTRY FUNCTION : System Description"
Automatic drive positioner system	ADP-13, "AUTOMATIC DRIVE POSITIONER SYSTEM : System Diagram"
Rear window defogger system	DEF-4, "System Diagram"

BODY CONTROL SYSTEM

< SYSTEM DESCRIPTION >

System	Refer to	
Intelligent Key system/engine start system	Door lock function	
	Trunk open function	
	Remote keyless entry function	DLK-15, "INTELLIGENT KEY SYSTEM : System Diagram"
	Key reminder function	
	Warning function	
Engine start function		
Power window system	PWC-7, "System Diagram"	
Retained accessory power (RAP) system	PWC-7, "System Description"	
Tire pressure monitor system (TPMS) - AIR PRESSURE MONITOR	WT-8, "System Diagram"	

Component Parts Location

INFOID:000000005656178

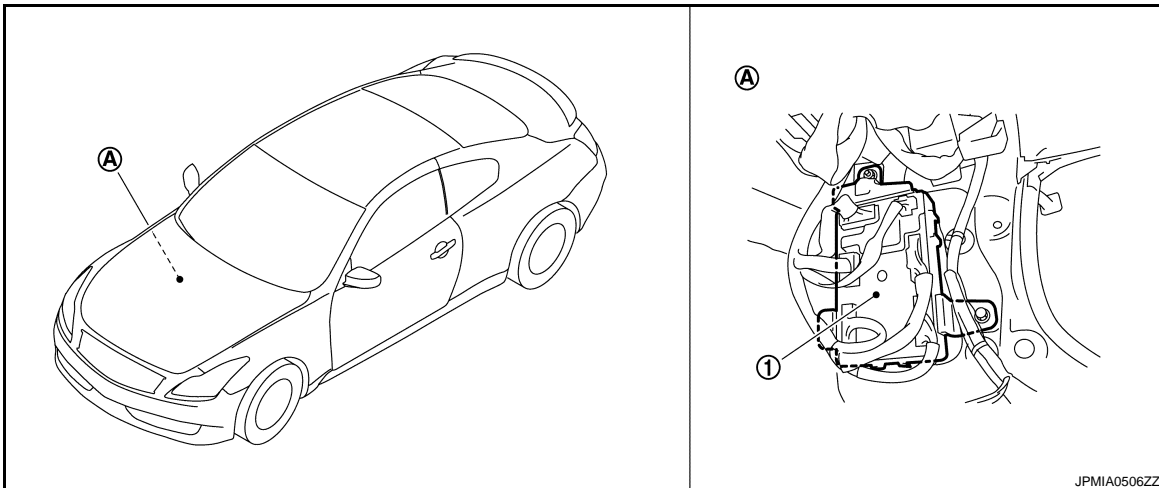

- 1. BCM
- A. Dash side lower (passenger side)

BCS

COMBINATION SWITCH READING SYSTEM

< SYSTEM DESCRIPTION >

COMBINATION SWITCH READING SYSTEM

System Diagram

INFOID:000000005656179

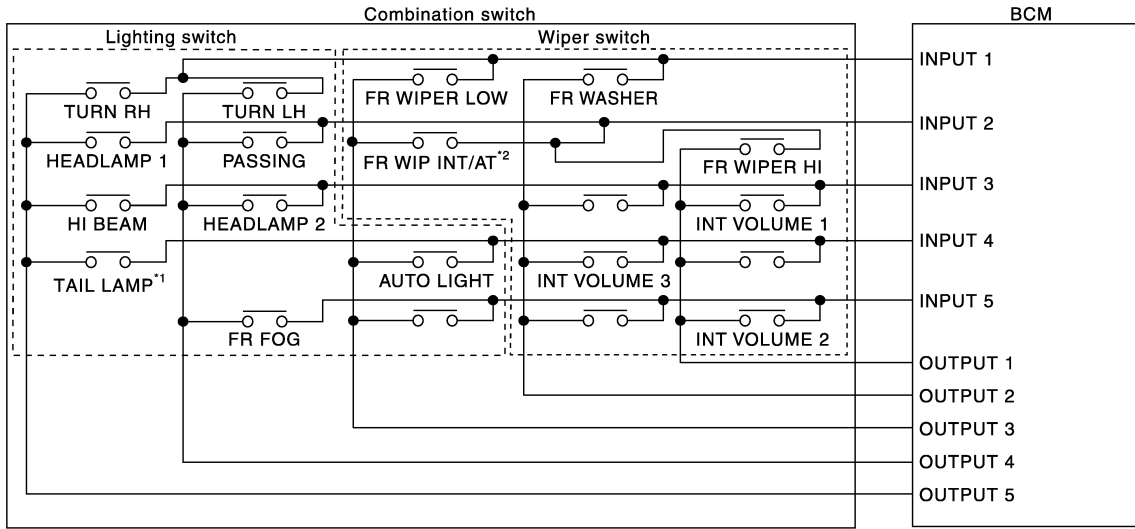

JMMIA0333GB

NOTE:

- *1: TAIL LAMP switch links lighting switch 1ST position.
- *2: "FR WIP INT/AT" is FR WIPER INT/AUTO.

System Description

INFOID:000000005656180

OUTLINE

- BCM reads the status of the combination switch (light, turn signal, wiper and washer) and recognizes the status of each switch.
- BCM is a combination of 5 output terminals (OUTPUT 1 - 5) and 5 input terminals (INPUT 1 - 5). It reads a maximum of 20 switch status.

COMBINATION SWITCH MATRIX

Combination switch circuit

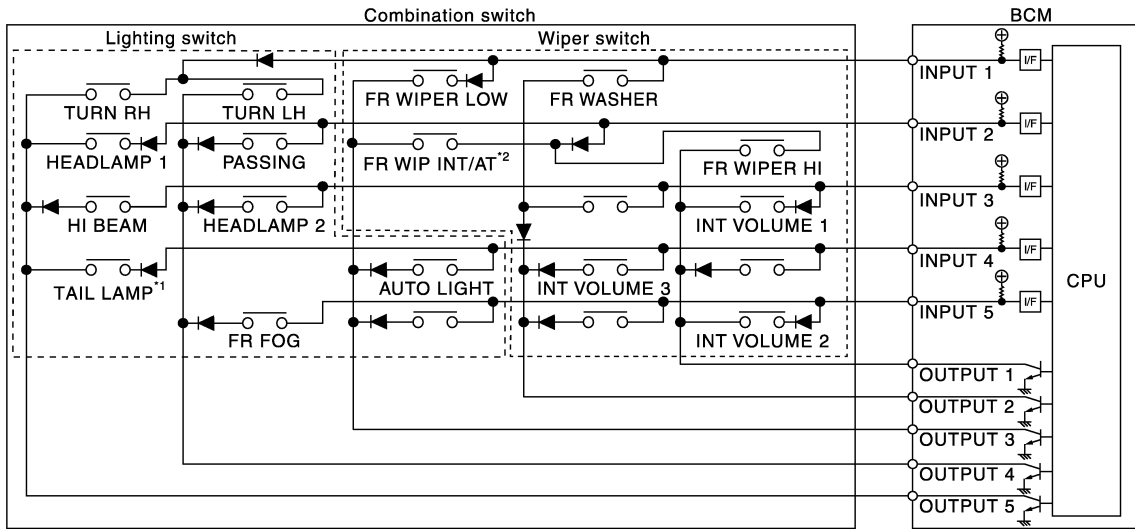

JMMIA0333GB

NOTE:

- *1: TAIL LAMP switch links lighting switch 1ST position.
- *2: "FR WIP INT/AT" is FR WIPER INT/AUTO.

COMBINATION SWITCH READING SYSTEM

< SYSTEM DESCRIPTION >

Combination switch INPUT-OUTPUT system list

System	OUTPUT 1	OUTPUT 2	OUTPUT 3	OUTPUT 4	OUTPUT 5
INPUT 1	—	FR WASHER	FR WIPER LOW	TURN LH	TURN RH
INPUT 2	FR WIPER HI	—	FR WIPER INT/AUTO	PASSING	HEADLAMP 1
INPUT 3	INT VOLUME 1	—	—	HEADLAMP 2	HI BEAM
INPUT 4	—	INT VOLUME 3	AUTO LIGHT	—	TAIL LAMP
INPUT 5	INT VOLUME 2	—	—	FR FOG	—

NOTE:

Headlamp has a dual system switch.

COMBINATION SWITCH READING FUNCTION

Description

- BCM reads the status of the combination switch at 10 ms interval normally.

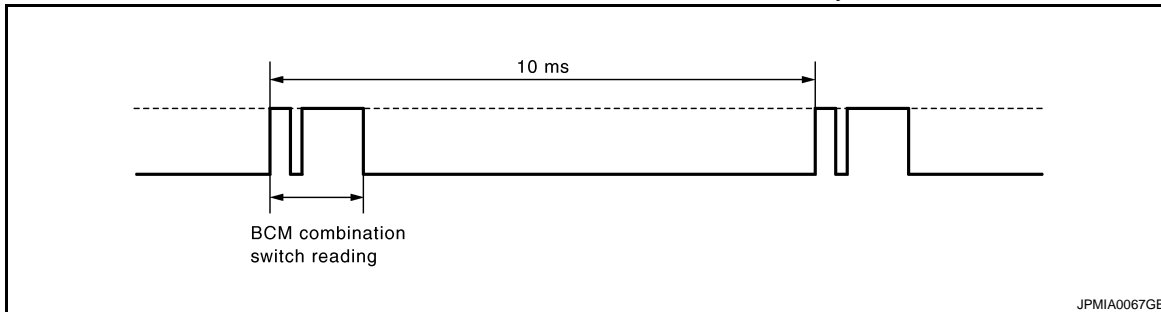

NOTE:

BCM reads the status of the combination switch at 60 ms interval when BCM is controlled at low power consumption mode.

- BCM operates as follows and judges the status of the combination switch.
 - INPUT 1 - 5 outputs the voltage waveforms of 5 systems simultaneously.
 - It operates the transistor on OUTPUT side in the following order: OUTPUT 5 → 4 → 3 → 2 → 1.
 - The voltage waveform of INPUT corresponding to the formed circuit changes according to the operation of the transistor on OUTPUT side if any (1 or more) switches are ON.
 - It reads this change of the voltage as the status signal of the combination switch.

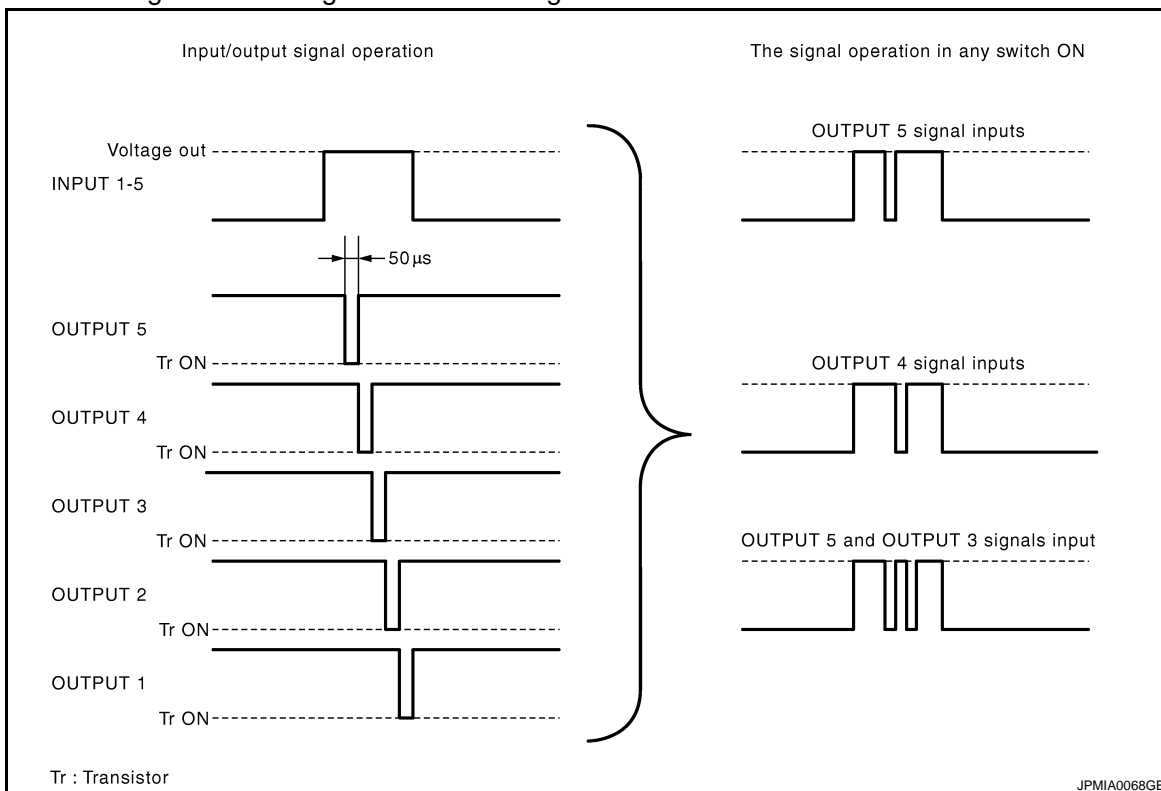

Tr : Transistor

JPMIA0068GB

A
B
C
D
E
F
G
H
I
J
K
L
N
O
P

BCS

COMBINATION SWITCH READING SYSTEM

< SYSTEM DESCRIPTION >

Operation Example

In the following operation example, the combination of the status signals of the combination switch is replaced as follows: INPUT 1 - 5 to "1 - 5" and OUTPUT 1 - 5 to "A - E".

Example 1: When a switch (TURN RH switch) is turned ON

- The circuit between INPUT 1 and OUTPUT 5 is formed when the TURN RH switch is turned ON.

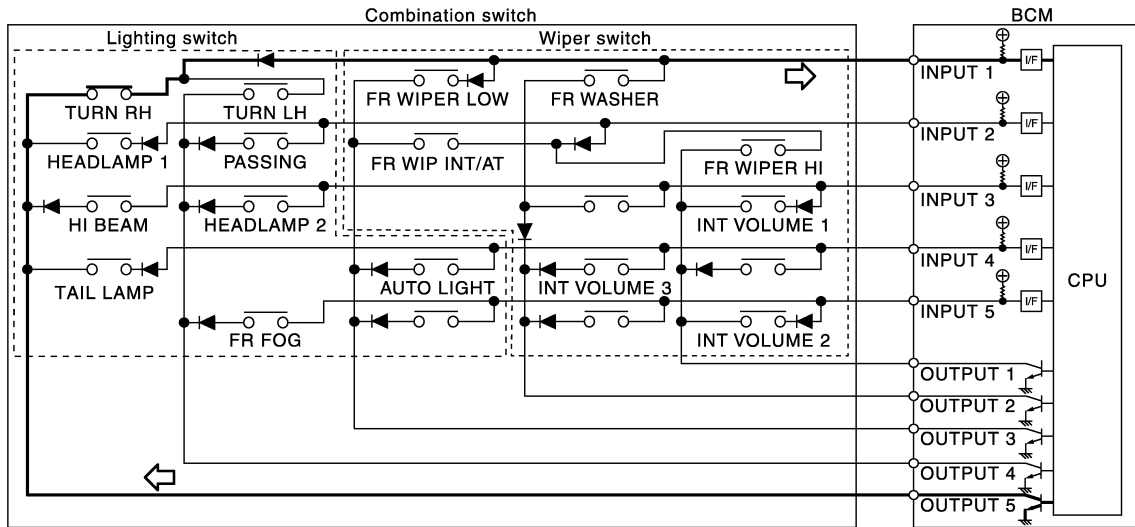

JMMIA0338GB

- BCM detects the combination switch status signal "1E" when the signal of OUTPUT 5 is input to INPUT 1.
- BCM judges that the TURN RH switch is ON when the signal "1E" is detected.

Example 2: When some switches (turn RH switch, front wiper LO switch) are turned ON

- The circuits between INPUT 1 and OUTPUT 5 and between INPUT 1 and OUTPUT 3 are formed when the TURN RH switch and FR WIPER LOW switch are turned ON.

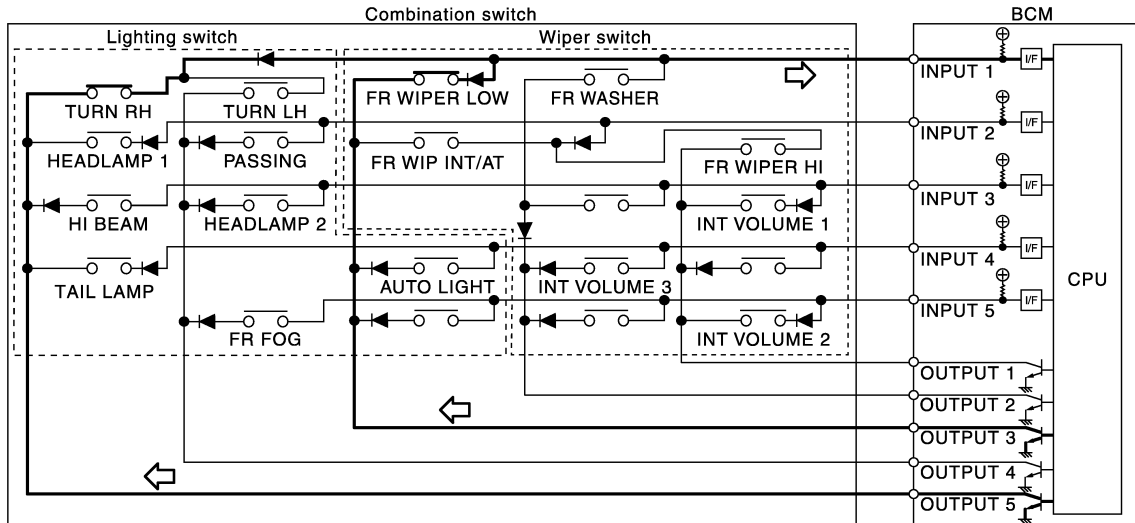

JMMIA0339GB

- BCM detects the combination switch status signal "1CE" when the signals of OUTPUT 3 and OUTPUT 5 are input to INPUT 1.
- BCM judges that the TURN RH switch and FR WIPER LOW switch are ON when the signal "1CE" is detected.

WIPER VOLUME DIAL POSITION

BCM judges the wiper volume dial 1 - 7 by the status of INT VOLUME 1, 2 and 3 switches.

Wiper volume dial position	Switch status		
	INT VOLUME 1	INT VOLUME 2	INT VOLUME 3
1	ON	ON	ON
2	ON	ON	OFF

COMBINATION SWITCH READING SYSTEM

< SYSTEM DESCRIPTION >

Wiper volume dial position	Switch status		
	INT VOLUME 1	INT VOLUME 2	INT VOLUME 3
3	ON	OFF	OFF
4	OFF	OFF	OFF
5	OFF	OFF	ON
6	OFF	ON	ON
7	OFF	ON	OFF

NOTE:

For details of wiper volume dial position, refer to [WW-8, "FRONT WIPER AND WASHER SYSTEM \(WITHOUT RAIN SENSOR\) : System Description"](#) (without rain sensor), [WW-11, "FRONT WIPER AND WASHER SYSTEM \(WITH RAIN SENSOR\) : System Description"](#) (with rain sensor).

A
B
C
D
E
F
G
H
I
J
K
L
N
O
P

BCS

SIGNAL BUFFER SYSTEM

< SYSTEM DESCRIPTION >

SIGNAL BUFFER SYSTEM

System Diagram

INFOID:000000005656182

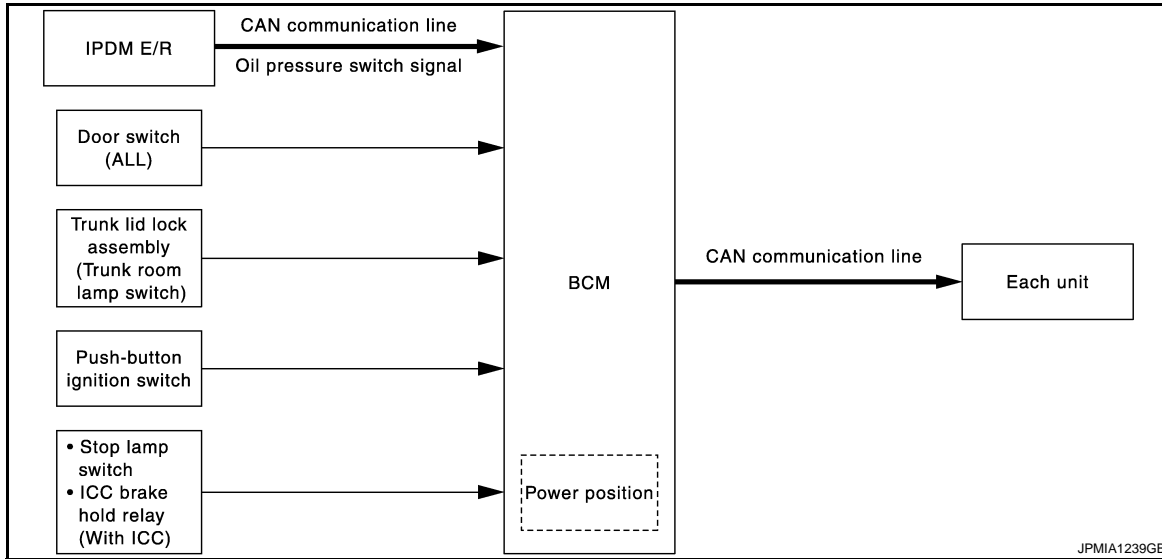

System Description

INFOID:000000005656183

OUTLINE

BCM has the signal transmission function that outputs/transmits each input/received signal to each unit.

Signal transmission function list

Signal name	Input	Output	Description
<ul style="list-style-type: none"> Ignition switch ON signal Ignition switch signal 	Push-button ignition switch (push switch)	<ul style="list-style-type: none"> IPDM E/R (CAN) Driver seat control unit (CAN) 	Inputs the push-button ignition switch (push switch) signal and transmits the ignition switch status judged with BCM via CAN communication.
Door switch signal	Any door switch	<ul style="list-style-type: none"> Combination meter (through unified meter and A/C amp.) (CAN) IPDM E/R (CAN) Driver seat control unit (CAN) 	Inputs the door switch signal and transmits it via CAN communication.
Trunk switch signal	Trunk room lamp switch	Combination meter (through unified meter and A/C amp.) (CAN)	Inputs the trunk room lamp switch signal and transmits the trunk switch signal via CAN communication.
Oil pressure switch signal	IPDM E/R (CAN)	Combination meter (through unified meter and A/C amp.) (CAN)	Transmits the received oil pressure switch signal via CAN communication.
Stop lamp switch signal	<ul style="list-style-type: none"> Stop lamp switch ICC brake hold relay (with ICC) 	TCM (CAN)	Inputs the stop lamp switch 1 signal and stop lamp switch 2 signal, and transmits the stop lamp switch signal via CAN communication.

POWER CONSUMPTION CONTROL SYSTEM

< SYSTEM DESCRIPTION >

POWER CONSUMPTION CONTROL SYSTEM

System Diagram

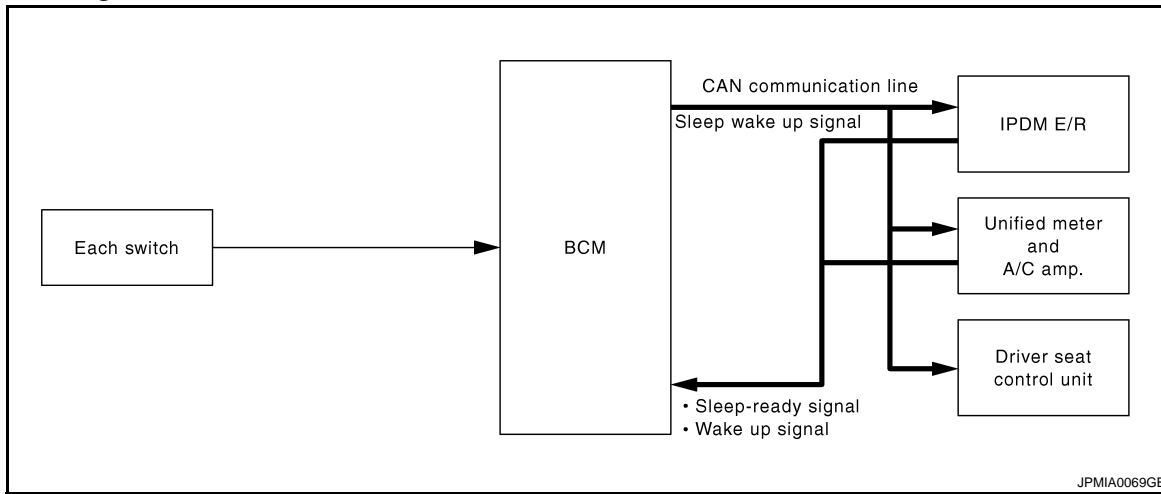

System Description

INFOID:000000005656185

OUTLINE

- BCM incorporates a power saving control function that reduces the power consumption according to the vehicle status.
- BCM switches the status (control mode) by itself with the power saving control function. It performs the sleep request to each unit [IPDM E/R, combination meter (unified meter and A/C amp.) and driver seat control unit] that operates with the ignition switch OFF.

Normal mode (wake-up)

- CAN communication is normally performed with other units
- Each control with BCM is operating properly

CAN communication sleep mode (CAN sleep)

- CAN transmission is stopped
- Control with BCM only is operating

Low power consumption mode (BCM sleep)

- Low power consumption control is active
- CAN transmission is stopped

LOW POWER CONSUMPTION CONTROL WITH BCM

BCM reduces the power consumption with the following operation in the low power consumption mode.

- The reading interval of the each switches changes from 10 ms interval to 60 ms interval.

Sleep mode activation

- BCM receives the sleep-ready signal (ready) from IPDM E/R and unified meter and A/C amp. via CAN communication.
- BCM transmits the sleep wake up signal (sleep) to each unit when all of the CAN sleep conditions are fulfilled.
- Each unit stops the transmission of CAN communication with the sleep wake up signal. BCM is in CAN communication sleep mode.
- BCM is in the low power consumption mode and perform the low power consumption control when all of the BCM sleep conditions are fulfilled with CAN sleep condition.

A
B
C
D
E
F
G
H
I
J
K
L
N
O
P

BCS

POWER CONSUMPTION CONTROL SYSTEM

< SYSTEM DESCRIPTION >

Sleep condition

CAN sleep condition	BCM sleep condition
<ul style="list-style-type: none"> • Receiving the sleep-ready signal (ready) from all units • Ignition switch: OFF • Vehicle security system and panic alarm: Not operation • Warning chime: Not operation • Intelligent Key system buzzer: Not operation • Trunk room lamp switch status: No change • Stop lamp switch: OFF • ICC brake hold relay (with ICC): OFF • Key slot (card switch) status: No change • Turn signal indicator lamp: Not operation • Exterior lamp: OFF • Door lock status: No change • CONSULT-III communication status: Not communication • Meter display signal: Non-transmission • Door switch status: No change • Rear window defogger: OFF 	<ul style="list-style-type: none"> • Interior room lamp battery saver: Time out • Power window switch communication: No transmission • Push-button ignition switch illumination: OFF • Infiniti Vehicle Immobilizer System (IVIS) - NATS: Not operation • Remote keyless entry receiver communication status: No communication • Tire pressure monitor system (TPMS) - AIR PRESSURE MONITOR: Stop • LOCK indicator lamp: OFF • ACC indicator lamp: OFF • ON indicator lamp: OFF

Wake-up operation

- BCM changes from the low power consumption mode to the CAN communication sleep mode when the any of the BCM wake-up conditions is fulfilled. Only the control with BCM is activated.
- BCM transmits the sleep wake up signal (wake up) to each unit when any of the CAN wake-up conditions is fulfilled. It changes from the low power consumption mode or the CAN communication sleep mode to the normal mode.
- Each unit starts the transmission of CAN communication with the sleep wake up signal. In addition, the unified meter and A/C amp. transmits the wake up signal to BCM via CAN communication to report the CAN communication start.

Wake-up condition

BCM wake-up condition	CAN wake-up condition
<ul style="list-style-type: none"> • Trunk lid opener switch: OFF → ON • Power window switch communication: Receiving • Remote keyless entry receiver communication: Receiving 	<ul style="list-style-type: none"> • Receiving the sleep-ready signal (Not-ready) from any units • Key slot (key switch): OFF → ON, ON → OFF • Push-button ignition switch (push switch): OFF → ON • Hazard switch: OFF → ON • PASSING switch: OFF → ON, ON → OFF • TAIL LAMP switch: OFF → ON • Driver door switch: OFF → ON, ON → OFF • Passenger door switch: OFF → ON, ON → OFF • Trunk room lamp switch: OFF → ON, ON → OFF • Driver door request switch: OFF → ON • Passenger door request switch: OFF → ON • Trunk lid opener request switch: OFF → ON • Stop lamp switch: ON • ICC brake hold relay (with ICC): ON • Clutch interlock switch: OFF → ON

POWER CONSUMPTION CONTROL SYSTEM

< SYSTEM DESCRIPTION >

Component Parts Location

INFOID:000000005656186

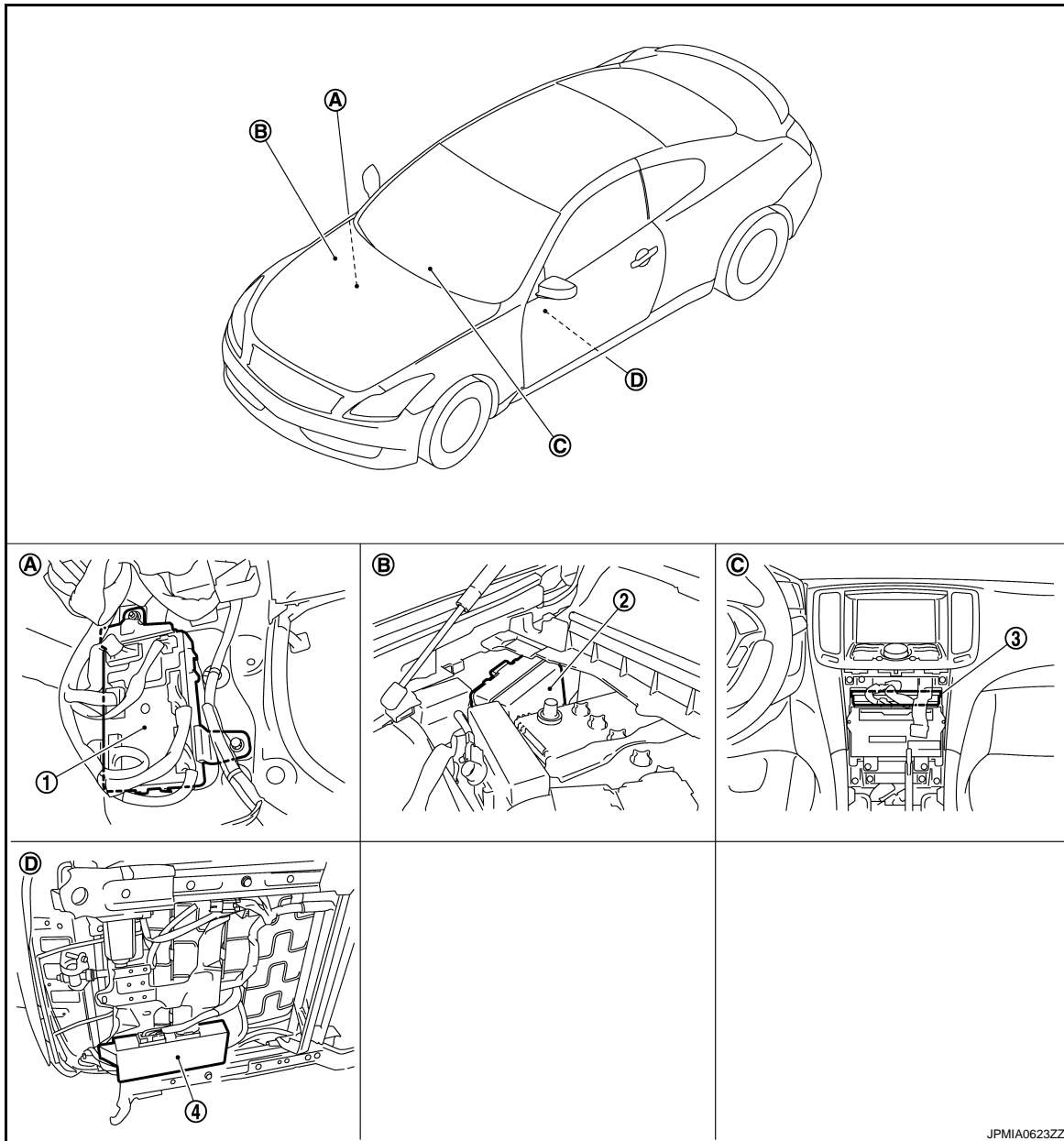

- | | | |
|---|--------------------------------|-------------------------------|
| 1. BCM | 2. IPDM E/R | 3. Unified meter and A/C amp. |
| 4. Driver seat control unit | | |
| A. Dash side lower (passenger side) | B. Engine room dash panel (RH) | C. Behind Cluster lid C |
| D. Backside of the seat cushion (driver seat) | | |

A
B
C
D
E
F
G
H
I
J
K
L

BCS

N
O
P

DIAGNOSIS SYSTEM (BCM)

< SYSTEM DESCRIPTION >

DIAGNOSIS SYSTEM (BCM)

COMMON ITEM

COMMON ITEM : CONSULT-III Function (BCM - COMMON ITEM)

INFOID:000000005656187

APPLICATION ITEM

CONSULT-III performs the following functions via CAN communication with BCM.

Diagnosis mode	Function Description
Work Support	Changes the setting for each system function.
Self Diagnostic Result	Displays the diagnosis results judged by BCM.
CAN Diag Support Monitor	Monitors the reception status of CAN communication viewed from BCM. Refer to CONSULT-III operation manual.
Data Monitor	The BCM input/output signals are displayed.
Active Test	The signals used to activate each device are forcibly supplied from BCM.
Ecu Identification	The BCM part number is displayed.
Configuration	This function is not used even though it is displayed.

SYSTEM APPLICATION

BCM can perform the following functions for each system.

NOTE:

It can perform the diagnosis modes except the following for all sub system selection items.

×: Applicable item

System	Sub system selection item	Diagnosis mode		
		Work Support	Data Monitor	Active Test
Door lock	DOOR LOCK	×	×	×
Rear window defogger	REAR DEFOGGER		×	×
Warning chime	BUZZER		×	×
Interior room lamp timer	INT LAMP	×	×	×
Exterior lamp	HEAD LAMP	×	×	×
Wiper and washer	WIPER	×	×	×
Turn signal and hazard warning lamps	FLASHER	×	×	×
—	AIR CONDITONER*			
<ul style="list-style-type: none"> • Intelligent Key system • Engine start system 	INTELLIGENT KEY	×	×	×
Combination switch	COMB SW		×	
Body control system	BCM	×		
IVIS - NATS	IMMU		×	×
Interior room lamp battery saver	BATTERY SAVER	×	×	×
Trunk lid open	TRUNK		×	×
Vehicle security system	THEFT ALM	×	×	×
RAP system	RETAINED PWR		×	
Signal buffer system	SIGNAL BUFFER		×	×
TPMS	AIR PRESSURE MONITOR	×	×	×

NOTE:

*: This item is displayed, but is not used.

FREEZE FRAME DATA (FFD)

The BCM records the following vehicle condition at the time a particular DTC is detected, and displays on CONSULT-III.

DIAGNOSIS SYSTEM (BCM)

< SYSTEM DESCRIPTION >

CONSULT screen item	Indication/Unit	Description		
Vehicle Speed	km/h	Vehicle speed of the moment a particular DTC is detected		A
Odo/Trip Meter	km	Total mileage (Odometer value) of the moment a particular DTC is detected		B
Vehicle Condition	SLEEP>LOCK	Power position status of the moment a particular DTC is detected	While turning BCM status from low power consumption mode to normal mode (Power supply position is "LOCK")	C
	SLEEP>OFF		While turning BCM status from low power consumption mode to normal mode (Power supply position is "OFF".)	D
	LOCK>ACC		While turning power supply position from "LOCK" to "ACC"	E
	ACC>ON		While turning power supply position from "ACC" to "IGN"	F
	RUN>ACC		While turning power supply position from "RUN" to "ACC" (Vehicle is stopping and selector lever is except P position.)	G
	CRANK>RUN		While turning power supply position from "CRANKING" to "RUN" (From cranking up the engine to run it)	H
	RUN>URGENT		While turning power supply position from "RUN" to "ACC" (Emergency stop operation)	I
	ACC>OFF		While turning power supply position from "ACC" to "OFF"	J
	OFF>LOCK		While turning power supply position from "OFF" to "LOCK"	K
	OFF>ACC		While turning power supply position from "OFF" to "ACC"	L
	ON>CRANK		While turning power supply position from "IGN" to "CRANKING"	
	OFF>SLEEP		While turning BCM status from normal mode (Power supply position is "OFF".) to low power consumption mode	
	LOCK>SLEEP		While turning BCM status from normal mode (Power supply position is "LOCK".) to low power consumption mode	
	LOCK		Power supply position is "LOCK" (Ignition switch OFF with steering is locked.)	
	OFF		Power supply position is "OFF" (Ignition switch OFF with steering is unlocked.)	
	ACC		Power supply position is "ACC" (Ignition switch ACC)	
ON	Power supply position is "IGN" (Ignition switch ON with engine stopped)			
ENGINE RUN	Power supply position is "RUN" (Ignition switch ON with engine running)			
CRANKING	Power supply position is "CRANKING" (At engine cranking)			
IGN Counter	0 - 39	The number of times that ignition switch is turned ON after DTC is detected <ul style="list-style-type: none"> • The number is 0 when a malfunction is detected now. • The number increases like 1 → 2 → 3...38 → 39 after returning to the normal condition whenever ignition switch OFF → ON. • The number is fixed to 39 until the self-diagnosis results are erased if it is over 39. 		BCS

DOOR LOCK

DOOR LOCK : CONSULT-III Function (BCM - DOOR LOCK)

INFOID:0000000005890802

BCM CONSULT-III FUNCTION

CONSULT-III performs the following functions via CAN communication with BCM.

Diagnosis mode	Function Description
WORK SUPPORT	Changes the setting for each system function.
DATA MONITOR	The BCM input/output signals are displayed.
ACTIVE TEST	The signals used to activate each device are forcibly supplied from BCM.

WORK SUPPORT

DIAGNOSIS SYSTEM (BCM)

< SYSTEM DESCRIPTION >

Monitor item	Description
DOOR LOCK-UNLOCK SET	Selective unlock function mode can be changed to operate (ON) or not operate (OFF) with this mode.
AUTOMATIC DOOR LOCK SELECT	Automatic door lock function mode can be selected from the following in this mode. <ul style="list-style-type: none"> VH SPD: All doors are locked when vehicle speed more than 24km/h (15MPH) P RANGE*: All doors are locked when shifting the selector lever from P position to other than the P position
AUTOMATIC DOOR UNLOCK SELECT	Automatic door unlock function mode can be selected from the following in the mode. <ul style="list-style-type: none"> MODE 1: All doors are unlocked when the power supply position is changed from ON to OFF MODE 2*: All doors are unlocked when shifting the selector lever from any position other than the P to P position MODE 3: Driver side door is unlocked when the power supply position is changed from ON to OFF MODE 4*: Driver side door is unlocked when shifting the selector lever from any position other than the P to P position
AUTOMATIC LOCK/UNLOCK SET	Automatic door lock/unlock function mode can be selected from the following in this mode. <ul style="list-style-type: none"> Off: non-operational Unlock Only: door unlock operation only Lock Only: door lock operation only Lock/Unlock: lock/unlock operation

*: P range interlock door lock can be selected for M/T models, but automatic door lock/unlock function does not operate.

DATA MONITOR

Monitor Item	Contents
REQ SW-DR	Indicated [ON/OFF] condition of door request switch (driver side).
REQ SW-AS	Indicated [ON/OFF] condition of door request switch (passenger side).
REQ SW-BD/TR	Indicated [ON/OFF] condition of trunk lid opener request switch.
DOOR SW-DR	Indicated [ON/OFF] condition of front door switch (driver side).
DOOR SW-AS	Indicated [ON/OFF] condition of front door switch (passenger side).
DOOR SW-RR	NOTE: This item is displayed, but cannot be monitored.
DOOR SW-RL	NOTE: This item is displayed, but cannot be monitored.
DOOR SW-BK	NOTE: This item is displayed, but cannot be monitored.
CDL LOCK SW	Indicated [ON/OFF] condition of lock signal from door lock unlock switch.
CDL UNLOCK SW	Indicated [ON/OFF] condition of unlock signal from door lock unlock switch.
KEY CYL LK-SW	Indicated [ON/OFF] condition of lock signal from door key cylinder.
KEY CYL UN-SW	Indicated [ON/OFF] condition of unlock signal from door key cylinder.

ACTIVE TEST

Test item	Description
DOOR LOCK	This test is able to check door lock/unlock operation. <ul style="list-style-type: none"> The all door lock actuators are locked when "ALL LCK" on CONSULT-III screen is touched. The all door lock actuators are unlocked when "ALL UNLK" on CONSULT-III screen is touched. The door lock actuator (driver side) is unlocked when "DR UNLK" on CONSULT-III screen is touched. The door lock actuator (passenger side) is unlocked when "AS UNLK" on CONSULT- III screen is touched. "OTR ULK" item is displayed, but cannot be monitored.

REAR WINDOW DEFOGGER

DIAGNOSIS SYSTEM (BCM)

< SYSTEM DESCRIPTION >

REAR WINDOW DEFOGGER : CONSULT-III Function (BCM - REAR DEFOGGER)

INFOID:000000005890808

Data monitor

Monitor Item	Description
REAR DEF SW	This is displayed even when it is not equipped.
PUSH SW	Indicates [ON/OFF] condition of push switch.

ACTIVE TEST

Test Item	Description
REAR DEFOGGER	This test is able to check rear window defogger operation. Rear window defogger operates when "ON" on CONSULT-III screen is touched.

BUZZER

BUZZER : CONSULT-III Function (BCM - BUZZER)

INFOID:000000005890816

CONSULT-III APPLICATION ITEMS

Test item	Diagnosis mode	Description
BUZZER	Data Monitor	Displays BCM input data in real time.
	Active Test	Operation of electrical loads can be checked by sending driving signal to them.

DATA MONITOR

Display item [Unit]	Description
VEH SPEED 1 [Km/h]	Value of vehicle speed signal received from ABS actuator and electric unit (control unit) with CAN communication line.
PUSH SW [On/Off]	Status of push button ignition switch judged by BCM.
UNLK SEN-DR [On/Off]	Status of unlock sensor judged by BCM.
KEY SW-SLOT [On/Off]	Status of key slot judged by BCM.
TAIL LAMP SW [On/Off]	Status of each switch judged by BCM using the combination switch readout function.
FR FOG SW [On/Off]	Status of front fog lamp switch judged by BCM.
DOOR SW-DR [On/Off]	Status of driver side door switch judged by BCM.

ACTIVE TEST

Display item [Unit]	Description
IGN KEY WARN ALM	The key warning chime operation can be checked by operating the relevant function (On/Off).
SEAT BELT WARN TEST	The seat belt warning chime operation can be checked by operating the relevant function (On/Off).
ID REGIST WARNING	The ID regist warning chime operation can be checked by operating the relevant function (On/Off).
LIGHT WARN ALM	The light warning chime operation can be checked by operating the relevant function (On/Off).
RUN FLAT/T WARN BUZZER	The run-flat tire warning chime operation can be checked by operating the relevant function (On/Off).

INT LAMP

DIAGNOSIS SYSTEM (BCM)

< SYSTEM DESCRIPTION >

INT LAMP : CONSULT-III Function (BCM - INT LAMP)

INFOID:000000005890809

WORK SUPPORT

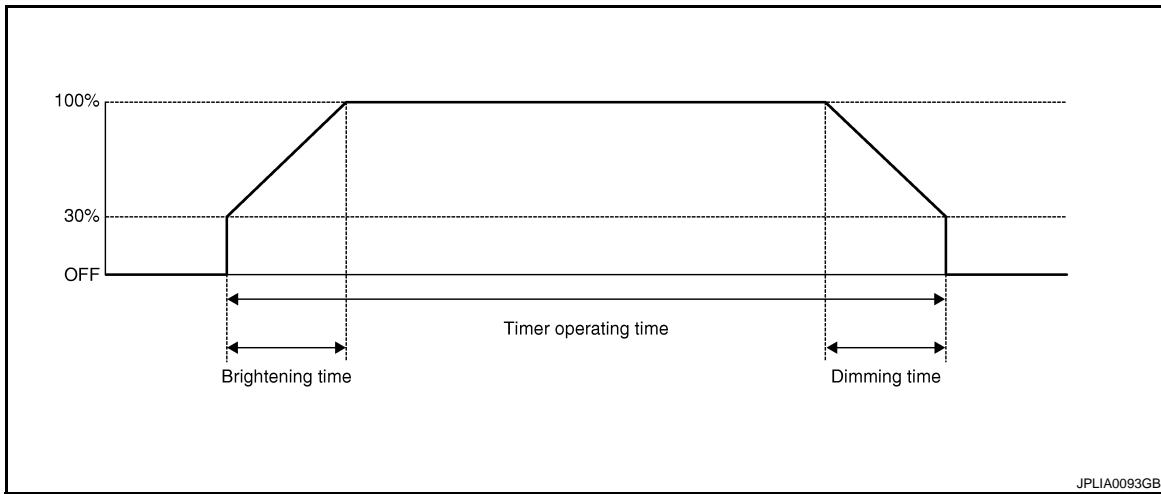

Service item	Setting item	Setting	
SET I/L D-UNLCK INTCON	ON*	With the interior room lamp timer function	
	OFF	Without the interior room lamp timer function	
ROOM LAMP TIMER SET	MODE 2	7.5 sec.	Sets the interior room lamp ON time. (Timer operating time)
	MODE 3*	15 sec.	
	MODE 4	30 sec.	
ROOM LAMP ON TIME SET	MODE 1	0.5 sec.	Sets the interior room lamp gradual brightening time.
	MODE 2*	1 sec.	
	MODE 3	2 sec.	
	MODE 4	3 sec.	
	MODE 5	0 sec.	
ROOM LAMP OFF TIME SET	MODE 1	0.5 sec.	Sets the interior room lamp gradual dimming time.
	MODE 2	1 sec.	
	MODE 3	2 sec.	
	MODE 4*	3 sec.	
R LAMP TIMER LOGIC SET	MODE 1*	Interior room lamp timer activates with synchronizing all doors.	
	MODE 2	Interior room lamp timer activates with synchronizing the driver door only.	

*: Factory setting

DATA MONITOR

Monitor item [Unit]	Description
REQ SW-DR [On/Off]	The switch status input from request switch (driver side)
REQ SW-AS [On/Off]	The switch status input from front request switch (passenger side)
PUSH SW [On/Off]	The switch status input from push-button ignition switch
ACC RLY-F/B [On/Off]	NOTE: The item is indicated, but not monitored.
KEY SW-SLOT [On/Off]	Key switch status input from key slot

DIAGNOSIS SYSTEM (BCM)

< SYSTEM DESCRIPTION >

Monitor item [Unit]	Description
DOOR SW-DR [On/Off]	The switch status input from driver side door switch
DOOR SW-AS [On/Off]	The switch status input from passenger side door switch
DOOR SW-RR [On/Off]	NOTE: The item is indicated, but not monitored.
DOOR SW- RL [On/Off]	
DOOR SW-BK [On/Off]	
CDL LOCK SW [On/Off]	Lock switch status received from the door lock and unlock switch by power window switch serial link
CDL UNLOCK SW [On/Off]	Unlock switch status received from the door lock and unlock switch by power window switch serial link
KEY CYL LK-SW [On/Off]	Lock switch status received from key cylinder switch by power window switch serial link
KEY CYL UN-SW [On/Off]	Unlock switch status received from key cylinder switch by power window switch serial link
TRNK/HAT MNTR [On/Off]	The switch status input from trunk room lamp switch
RKE-LOCK [On/Off]	Lock signal status received from remote keyless entry receiver
RKE-UNLOCK [On/Off]	Unlock signal status received from remote keyless entry receiver

ACTIVE TEST

Test item	Operation	Description
INT LAMP	On	Outputs the interior room lamp control signal to turn map lamp ON (Map lamp switch is in DOOR position).
	Off	Stops the interior room lamp control signal to turn map lamp OFF.
STEP LAMP TEST	On	Outputs the step lamp control signal to turn step lamp ON.
	Off	Stops the step lamp control signal to turn step lamp OFF.
LUGGAGE LAMP TEST	On	Outputs the trunk room lamp control signal to turn the trunk room lamp ON.
	Off	Stops the trunk room lamp control signal to turn the trunk room lamp OFF.

HEADLAMP

HEADLAMP : CONSULT-III Function (BCM - HEAD LAMP)

INFOID:000000005890811

WORK SUPPORT

Service item	Setting item	Setting
BATTERY SAVER SET	On*	With the exterior lamp battery saver function
	Off	Without the exterior lamp battery saver function

DIAGNOSIS SYSTEM (BCM)

< SYSTEM DESCRIPTION >

Service item	Setting item	Setting
ILL DELAY SET	MODE 1*	45 sec.
	MODE 2	Without the function
	MODE 3	30 sec.
	MODE 4	60 sec.
	MODE 5	90 sec.
	MODE 6	120 sec.
	MODE 7	150 sec.
	MODE 8	180 sec.
Sets delay timer function timer operation time. (All doors closed)		
CUSTOM A/LIGHT SETTING	MODE 1*	Normal
	MODE 2	More sensitive setting than normal setting (Turns ON earlier than normal operation.)
	MODE 3	More sensitive setting than MODE 2 (Turns ON earlier than MODE 2.)
	MODE 4	Less sensitive setting than normal setting (Turns ON later than normal operation.)

*: Factory setting

DATA MONITOR

Monitor item [Unit]	Description	
PUSH SW [On/Off]	The switch status input from push-button ignition switch	
ENGINE STATE [Stop/Stall/Crank/Run]	The engine status received from ECM with CAN communication	
VEH SPEED 1 [km/h]	The value of the vehicle speed received from unified meter and A/C amp. with CAN communication	
KEY SW-SLOT [On/Off]	Key switch status input from key slot	
TURN SIGNAL R [On/Off]	Each switch status that BCM judges from the combination switch reading function	
TURN SIGNAL L [On/Off]		
TAIL LAMP SW [On/Off]		
HI BEAM SW [On/Off]		
HEAD LAMP SW1 [On/Off]		
HEAD LAMP SW2 [On/Off]		
PASSING SW [On/Off]		
AUTO LIGHT SW [On/Off]		
FR FOG SW [On/Off]		
RR FOG SW [On/Off]		
DOOR SW-DR [On/Off]		The switch status input from driver side door switch
DOOR SW-AS [On/Off]		The switch status input from passenger side door switch

NOTE:
The item is indicated, but not monitored.

DIAGNOSIS SYSTEM (BCM)

< SYSTEM DESCRIPTION >

Monitor item [Unit]	Description
DOOR SW-RR [On/Off]	NOTE: The item is indicated, but not monitored.
DOOR SW- RL [On/Off]	NOTE: The item is indicated, but not monitored.
DOOR SW-BK [On/Off]	NOTE: The item is indicated, but not monitored.
OPTICAL SENSOR [V]	The value of exterior brightness voltage input from the optical sensor

ACTIVE TEST

Test item	Operation	Description
TAIL LAMP	On	Transmits the position light request signal to IPDM E/R with CAN communication to turn the tail lamp ON.
	Off	Stops the position light request signal transmission.
HEAD LAMP	Hi	Transmits the high beam request signal with CAN communication to turn the headlamp (HI).
	Low	Transmits the low beam request signal with CAN communication to turn the headlamp (LO).
	Off	Stops the high & low beam request signal transmission.
FR FOG LAMP	On	Transmits the front fog light request signal to IPDM E/R with CAN communication to turn the front fog lamp ON.
	Off	Stops the front fog light request signal transmission.
RR FOG LAMP	On	NOTE: The item is indicated, but cannot be tested.
	Off	
DAYTIME RUNNING LIGHT	On	NOTE: The item is indicated, but cannot be tested.
	Off	
CORNERING LAMP	RH	NOTE: The item is indicated, but cannot be tested.
	LH	
	Off	
ILL DIM SIGNAL	On	NOTE: The item is indicated, but cannot be tested.
	Off	

WIPER

WIPER : CONSULT-III Function (BCM - WIPER)

INFOID:000000005890813

BCS

WORK SUPPORT

Service item	Setting item	Description
WIPER SPEED SETTING*1	On	Linked with vehicle speed (Front wiper intermittent time linked with the vehicle speed and wiper intermittent dial position)
	Off*2	Not linked with vehicle speed (Front wiper intermittent time linked with the wiper intermittent dial position)

*1:Without rain sensor

*2:Initial setting

DATA MONITOR

DIAGNOSIS SYSTEM (BCM)

< SYSTEM DESCRIPTION >

Monitor Item [Unit]	Description
VEH SPEED 1 [km/h]	Displays the value of the vehicle speed signal received from unified meter and A/C amp. with CAN communication.
PUSH SW [Off/On]	The switch status input from push-button ignition switch.
FR WIPER HI [Off/On]	Status of each switch judged by BCM using the combination switch reading function
FR WIPER LOW [Off/On]	
FR WASHER SW [Off/On]	
FR WIPER INT [Off/On]	
FR WIPER STOP [Off/On]	Displays the status of the front wiper stop position signal received from IPDM E/R with CAN communication.
INT VOLUME [1 - 7]	Status of each switch judged by BCM using the combination switch reading function

ACTIVE TEST

Test item	Operation	Description
FRONT WIPER	Hi	Transmits the front wiper request signal (HI) to IPDM E/R with CAN communication to operate the front wiper HI operation.
	Lo	Transmits the front wiper request signal (LO) to IPDM E/R with CAN communication to operate the front wiper LO operation.
	INT	Transmits the front wiper request signal (INT) to IPDM E/R with CAN communication to operate the front wiper INT operation.
	Off	Stops transmitting the front wiper request signal to stop the front wiper operation.

FLASHER

FLASHER : CONSULT-III Function (BCM - FLASHER)

INFOID:000000005890812

WORK SUPPORT

Service item	Setting item	Setting
HAZARD ANSWER BACK	Lock Only*	With locking only
	Unlk Only	With unlocking only
	Lock/Unlk	With locking/unlocking
	Off	Without the function
		Sets the hazard warning lamp answer back function when the door is lock/unlock with the request switch or the key fob.

*: Factory setting

DATA MONITOR

Monitor item [Unit]	Description
REQ SW-DR [On/Off]	The switch status input from the request switch (driver side)
REQ SW-AS [On/Off]	The switch status input from the request switch (passenger side)
PUSH SW [On/Off]	The switch status input from the push-button ignition switch

DIAGNOSIS SYSTEM (BCM)

< SYSTEM DESCRIPTION >

Monitor item [Unit]	Description
TURN SIGNAL R [On/Off]	Each switch condition that BCM judges from the combination switch reading function
TURN SIGNAL L [On/Off]	
HAZARD SW [On/Off]	The switch status input from the hazard switch
RKE-LOCK [On/Off]	Lock signal status received from the remote keyless entry receiver
RKE-UNLOCK [On/Off]	Unlock signal status received from the remote keyless entry receiver
RKE-PANIC [On/Off]	Panic alarm signal status received from the remote keyless entry receiver

ACTIVE TEST

Test item	Operation	Description
FLASHER	RH	Outputs the voltage to blink the right side turn signal lamps.
	LH	Outputs the voltage to blink the left side turn signal lamps.
	Off	Stops the voltage to turn the turn signal lamps OFF.

INTELLIGENT KEY

INTELLIGENT KEY : CONSULT-III Function (BCM - INTELLIGENT KEY)

INFOID:0000000005890803

WORK SUPPORT

Monitor item	Description
CONFIRM KEY FOB ID	It can be checked whether Intelligent Key ID code is registered or not in this mode.
AUTO LOCK SET	Auto door lock time can be changed in this mode. <ul style="list-style-type: none"> • MODE 1: 1 minute • MODE 2: 5 minutes • MODE 3: 30 seconds • MODE 4: 2 minutes
LOCK/UNLOCK BY I-KEY	Door lock/unlock function by door request switch (driver side and passenger side) mode can be changed to operate (ON) or not operate (OFF) in this mode.
ENGINE START BY I-KEY	Engine start function mode can be changed to operate (ON) or not operate (OFF) with this mode.
TRUNK/GLASS HATCH OPEN	Buzzer reminder function mode by trunk opener request switch can be changed to operate (ON) or not operate (OFF) with this mode.
PANIC ALARM SET	Panic alarm button pressing time on Intelligent Key remote control button can be selected from the following with this mode. <ul style="list-style-type: none"> • MODE 1: 0.5 sec. • MODE 2: Non-operation • MODE 3: 1.5 sec.
PW DOWN SET	Unlock button pressing time on Intelligent Key button can be selected from the following with this mode. <ul style="list-style-type: none"> • MODE 1: 3 sec. • MODE 2: Non-operation • MODE 3: 5 sec.
TRUNK OPEN DELAY	Trunk button pressing on Intelligent Key button can be selected as per the following in this mode. <ul style="list-style-type: none"> • MODE 1: Press and hold • MODE 2: Press twice • MODE 3: Press and hold, or press twice

DIAGNOSIS SYSTEM (BCM)

< SYSTEM DESCRIPTION >

Monitor item	Description
LO- BATT OF KEY FOB WARN	Intelligent Key low battery warning mode can be changed to operate (ON) or not operate (OFF) with this mode.
ANTI KEY LOCK IN FUNCTI	Key reminder function mode can be changed to operate (ON) or not operate (OFF) with this mode.
HAZARD ANSWER BACK	Hazard reminder function mode can be selected from the following with this mode. <ul style="list-style-type: none"> • LOCK ONLY: Door lock operation only • UNLOCK ONLY: Door unlock operation only • LOCK/UNLOCK: Lock/unlock operation • OFF: Non-operation
ANS BACK I-KEY LOCK	Buzzer reminder function (lock operation) mode by door request switch (driver side and passenger side) can be selected from the following with this mode. <ul style="list-style-type: none"> • Horn chirp: Sound horn • Buzzer: Sound Intelligent Key warning buzzer • OFF: Non-operation
ANS BACK I-KEY UNLOCK	Buzzer reminder function (unlock operation) mode by door request switch can be changed to operate (ON) or not operate (OFF) with this mode.
SHORT CRANKING OUTPUT	Starter motor can operate during the times below. <ul style="list-style-type: none"> • 70 msec • 100 msec • 200 msec
INSIDE ANT DIAGNOSIS	This function allows inside key antenna self-diagnosis.
HORN WITH KEYLESS LOCK	Horn reminder function mode by Intelligent Key button can be changed to operate (ON) or not operate (OFF) with this mode.

SELF-DIAG RESULT

Refer to [DLK-165. "DTC Index"](#).

DATA MONITOR

Monitor Item	Condition
REQ SW -DR	Indicates [ON/OFF] condition of door request switch (driver side).
REQ SW -AS	Indicates [ON/OFF] condition of door request switch (passenger side).
REQ SW -BD/TR	Indicates [ON/OFF] condition of trunk opener request switch.
PUSH SW	Indicates [ON/OFF] condition of push-button ignition switch.
IGN RLY2 -F/B	Indicates [ON/OFF] condition of ignition relay 2.
ACC RLY-FB	NOTE: This item is displayed, but cannot be monitored.
CLUTCH SW* ¹	Indicates [ON/OFF] condition of clutch switch.
BRAKE SW 1	Indicates [ON/OFF]* ² condition of brake switch power supply.
BRAKE SW 2	Indicates [ON/OFF] condition of brake switch.
DETE/CANCL SW	Indicates [ON/OFF] condition of P position.
SFT PN/N SW	Indicates [ON/OFF] condition of P or N position.
S/L -LOCK	Indicates [ON/OFF] condition of steering lock unit (LOCK).
S/L -UNLOCK	Indicates [ON/OFF] condition of steering lock unit (UNLOCK).
S/L RELAY -F/B	Indicates [ON/OFF] condition of steering lock relay.
UNLK SEN -DR	Indicates [ON/OFF] condition of driver door UNLOCK status.
PUSH SW -IPDM	Indicates [ON/OFF] condition of push-button ignition switch.
IGN RLY1 -F/B	Indicates [ON/OFF] condition of ignition relay 1.
DETE SW -IPDM	Indicates [ON/OFF] condition of P position.
SFT PN -IPDM	Indicates [ON/OFF] condition of P or N position.
SFT P -MET	Indicates [ON/OFF] condition of P position.

DIAGNOSIS SYSTEM (BCM)

< SYSTEM DESCRIPTION >

Monitor Item	Condition
SFT N -MET	Indicates [ON/OFF] condition of N position.
ENGINE STATE	Indicates [STOP/STALL/CRANK/RUN] condition of engine states.
S/L LOCK-IPDM	Indicates [ON/OFF] condition of steering lock unit (LOCK).
S/L UNLK-IPDM	Indicates [ON/OFF] condition of steering lock unit (UNLOCK).
S/L RELAY-REQ	Indicates [ON/OFF] condition of steering lock relay.
VEH SPEED 1	Display the vehicle speed signal received from combination meter by numerical value [Km/h].
VEH SPEED 2	Display the vehicle speed signal received from ABS or VDC or TCM by numerical value [Km/h].
DOOR STAT-DR	Indicates [LOCK/READY/UNLOCK] condition of driver side door status.
DOOR STAT-AS	Indicates [LOCK/READY/UNLOCK] condition of passenger side door status.
ID OK FLAG	Indicates [SET/RESET] condition of key ID.
PRMT ENG STRT	Indicates [SET/RESET] condition of engine start possibility.
PRMT RKE STRT	NOTE: This item is displayed, but cannot be monitored.
KEY SW -SLOT	Indicates [ON/OFF] condition of key slot.
TRNK/HAT MNTR	Indicates [ON/OFF] condition of trunk lid.
RKE-LOCK	Indicates [ON/OFF] condition of LOCK signal from Intelligent Key.
RKE-UNLOCK	Indicates [ON/OFF] condition of UNLOCK signal from Intelligent Key.
RKE-TR/BD	Indicates [ON/OFF] condition of TRUNK OPEN signal from Intelligent Key.
RKE-PANIC	Indicates [ON/OFF] condition of PANIC button of Intelligent Key.
RKE-P/W OPEN	Indicates [ON/OFF] condition of P/W DOWN signal from Intelligent Key.
RKE-MODE CHG	Indicates [ON/OFF] condition of MODE CHANGE signal from Intelligent Key.
RKE OPE COUN1	When remote keyless entry receiver receives the signal transmitted while operating on Intelligent Key, the numerical value start changing.
RKE OPE COUN2	NOTE: This item is displayed, but cannot be monitored.

*1: It is displayed but does not operate on M/T models.

*2: OFF is displayed when brake pedal is depressed while brake switch power supply is OFF.

ACTIVE TEST

Test item	Description
BATTERY SAVER	This test is able to check interior room lamp operation. The interior room lamp is activated after "ON" on CONSULT-III screen is touched.
PW REMOTO DOWN SET	This test is able to check power window down operation. The power window down is activated after "ON" on CONSULT-III screen is touched.
OUTSIDE BUZZER	This test is able to check Intelligent Key warning buzzer operation. The Intelligent Key warning buzzer is activated after "ON" on CONSULT-III screen is touched.
INSIDE BUZZER	This test is able to check warning chime in combination meter operation. <ul style="list-style-type: none"> Take away warning chime sounds when "TAKE OUT" on CONSULT-III screen is touched. Key warning chime sounds when "KEY" on CONSULT-III screen is touched. OFF position warning chime sounds when "KNOB" on CONSULT-III screen is touched.
INDICATOR	This test is able to check warning lamp operation. <ul style="list-style-type: none"> "KEY" Warning lamp illuminates when "KEY ON" on CONSULT-III screen is touched. "KEY" Warning lamp blinks when "KEY IND" on CONSULT-III screen is touched.
INT LAMP	This test is able to check interior room lamp operation. The interior room lamp is activated after "ON" on CONSULT-III screen is touched.

DIAGNOSIS SYSTEM (BCM)

< SYSTEM DESCRIPTION >

Test item	Description
LCD	<p>This test is able to check meter display information</p> <ul style="list-style-type: none"> • Engine start information displays when "BP N" on CONSULT-III screen is touched. • Engine start information displays when "BP I" on CONSULT-III screen is touched. • Key ID warning displays when "ID NG" on CONSULT-III screen is touched. • Steering lock information displays when "ROTAT" on CONSULT-III screen is touched. • P position warning displays when "SFT P" on CONSULT-III screen is touched. • Intelligent Key insert information displays when "INSRT" on CONSULT-III screen is touched. • Intelligent Key low battery warning displays when "BATT" on CONSULT-III screen is touched. • Take away through window warning displays when "NO KY" on CONSULT-III screen is touched. • Take away warning display when "OUTKEY" on CONSULT-III screen is touched. • OFF position warning display when "LK WN" on CONSULT-III screen is touched.
TRUNK/GLASS HATCH	<p>This test is able to check trunk lid opener actuator open operation. This actuator opens when "OPEN" on CONSULT-III screen is touched.</p>
FLASHER	<p>This test is able to check security hazard lamp operation. The hazard lamps are activated after "LH/RH/OFF" on CONSULT-III screen is touched.</p>
HORN	<p>This test is able to check horn operation. The horn is activated after "ON" on CONSULT-III screen is touched.</p>
P RANGE	<p>This test is able to check A/T shift selector power supply A/T shift selector power is supplied when "ON" on CONSULT-III screen is touched.</p>
ENGINE SW ILLUMI	<p>This test is able to check push-ignition switch illumination operation. Push-ignition switch illumination illuminates when "ON" on CONSULT-III screen is touched.</p>
LOCK INDICATOR	<p>This test is able to check LOCK indicator in push-ignition switch operation. LOCK indicator in push-ignition switch illuminates when "ON" on CONSULT-III screen is touched.</p>
ACC INDICATOR	<p>This test is able to check ACC indicator in push-ignition switch operation. ACC indicator in push-ignition switch illuminates when "ON" on CONSULT-III screen is touched.</p>
IGNITION ON IND	<p>This test is able to check on indicator in push-ignition switch operation. ON indicator in push-ignition switch illuminates when "ON" on CONSULT-III screen is touched.</p>
KEY SLOT ILLUMI	<p>This test is able to check key slot illumination operation. Key slot illumination blinks when "ON" on CONSULT-III screen is touched.</p>
TRUNK/BACK DOOR	<p>This test is able to check trunk lid opener actuator open operation. This actuator opens when "OPEN" on CONSULT-III screen is touched.</p>

COMB SW

COMB SW : CONSULT-III Function (BCM - COMB SW)

INFOID:000000005656196

DATA MONITOR

Monitor item [UNIT]	Description
FR WIPER HI [Off/On]	Displays the status of the FR WIPER HI switch in combination switch judged by BCM with the combination switch reading function.
FR WIPER LOW [Off/On]	Displays the status of the FR WIPER LOW switch in combination switch judged by BCM with the combination switch reading function.
FR WASHER SW [Off/On]	Displays the status of the FR WASHER switch in combination switch judged by BCM with the combination switch reading function.
FR WIPER INT [Off/On]	Displays the status of the FR WIPER INT/AUTO switch in combination switch judged by BCM with the combination switch reading function.
FR WIPER STOP [Off/On]	Displays the status of the front wiper stop position signal received from IPDM E/R via CAN communication.
INT VOLUME [1 - 7]	Displays the status of wiper volume dial position judged by BCM with the combination switch reading function.

DIAGNOSIS SYSTEM (BCM)

< SYSTEM DESCRIPTION >

Monitor item [UNIT]	Description
TURN SIGNAL R [Off/On]	Displays the status of the TURN RH switch in combination switch judged by BCM with the combination switch reading function.
TURN SIGNAL L [Off/On]	Displays the status of the TURN LH switch in combination switch judged by BCM with the combination switch reading function.
TAIL LAMP SW [Off/On]	Displays the status of the TAIL LAMP switch in combination switch judged by BCM with the combination switch reading function.
HI BEAM SW [Off/On]	Displays the status of the HI BEAM switch in combination switch judged by BCM with the combination switch reading function.
HEAD LAMP SW 1 [Off/On]	Displays the status of the HEADLAMP 1 switch in combination switch judged by BCM with the combination switch reading function.
HEAD LAMP SW 2 [Off/On]	Displays the status of the HEADLAMP 2 switch in combination switch judged by BCM with the combination switch reading function.
PASSING SW [Off/On]	Displays the status of the PASSING switch in combination switch judged by BCM with the combination switch reading function.
AUTO LIGHT SW [Off/On]	Displays the status of the AUTO LIGHT switch in combination switch judged by BCM with the combination switch reading function.
FR FOG SW [Off/On]	Displays the status of the FR FOG switch in combination switch judged by BCM with the combination switch reading function.
RR FOG SW [Off/On]	NOTE: The item is indicated, but not monitored.

BCM

BCM : CONSULT-III Function (BCM - BCM)

INFOID:000000005656197

WORK SUPPORT

Item	Description
RESET SETTING VALUE	Return a value set with Work Support of each system to a default value in factory shipment.

IMMU

IMMU : CONSULT-III Function (BCM - IMMU)

INFOID:000000005890806

DATA MONITOR

Monitor item	Content
CONFIRM ID ALL	Indicates [YET] at all time. Switch to [DONE] when a registered Intelligent Key is inserted into the key slot.
CONFIRM ID4	
CONFIRM ID3	
CONFIRM ID2	
CONFIRM ID1	
TP 4	Indicates the number of ID which has been registered.
TP 3	
TP 2	
TP 1	
PUSH SW	Indicates [ON/OFF] condition of push-button ignition switch.
KEY SW -SLOT	Indicates [ON/OFF] condition of key slot.

ACTIVE TEST

A
B
C
D
E
F
G
H
I
J
K
L

BCS

N
O
P

DIAGNOSIS SYSTEM (BCM)

< SYSTEM DESCRIPTION >

Test item	Description
THEFT IND	This test is able to check security indicator lamp operation. The lamp will be turned on when "ON" on CONSULT-III screen touched.

BATTERY SAVER

BATTERY SAVER : CONSULT-III Function (BCM - BATTERY SAVER)

INFOID:000000005890810

WORK SUPPORT

Service item	Setting item	Setting	
BATTERY SAVER SET	On*	With the exterior lamp battery saver function	
	Off	Without the exterior lamp battery saver function	
ROOM LAMP BAT SAV SET	On*	With the interior room lamp battery saver function	
	Off	Without the interior room lamp battery saver function	
ROOM LAMP TIMER SET	MODE 1*	30 min.	Sets the interior room lamp battery saver timer operating time.
	MODE 2	60 min.	

*: Factory setting

DATA MONITOR

Monitor item [Unit]	Description
REQ SW-DR [On/Off]	The switch status input from request switch (driver side)
REQ SW-AS [On/Off]	The switch status input from front request switch (passenger side)
REQ SW-RR [On/Off]	NOTE: The item is indicated, but not monitored.
REQ SW-RL [On/Off]	
PUSH SW [On/Off]	The switch status input from push-button ignition switch
ACC RLY-F/B [On/Off]	NOTE: The item is indicated, but not monitored.
KEY SW-SLOT [On/Off]	Key switch status input from key slot
UNLK SEN-DR [On/Off]	Driver door unlock status input from unlock sensor
DOOR SW-DR [On/Off]	The switch status input driver side front door switch
DOOR SW-AS [On/Off]	The switch status input from passenger side door switch
DOOR SW-RR [On/Off]	NOTE: The item is indicated, but not monitored.
DOOR SW- RL [On/Off]	
DOOR SW-BK [On/Off]	
CDL LOCK SW [On/Off]	Lock switch status received from the door lock and unlock switch by power window switch serial link
CDL UNLOCK SW [On/Off]	Unlock switch status received from the door lock and unlock switch by power window switch serial link

DIAGNOSIS SYSTEM (BCM)

< SYSTEM DESCRIPTION >

Monitor item [Unit]	Description
KEY CYL LK-SW [On/Off]	Lock switch status received from key cylinder switch by power window switch serial link
KEY CYL UN-SW [On/Off]	Unlock switch status received from key cylinder switch by power window switch serial link
TRNK/HAT MNTR [On/Off]	The switch status input from trunk room lamp switch
RKE-LOCK [On/Off]	Lock signal status received from remote keyless entry receiver
RKE-UNLOCK [On/Off]	Unlock signal status received from remote keyless entry receiver

ACTIVE TEST

Test item	Operation	Description
BATTERY SAVER	Off	Cuts the interior room lamp power supply to turn interior room lamp OFF.
	On	Outputs the interior room lamp power supply to turn interior room lamp ON.*

*: Each lamp switch is in ON position.

TRUNK

TRUNK : CONSULT-III Function (BCM - TRUNK)

INFOID:0000000005890804

BCM CONSULT-III FUNCTION

CONSULT-III performs the following functions via CAN communication with BCM.

Diagnosis mode	Function Description
DATA MONITOR	The BCM input/output signals are displayed.

DATA MONITOR

Monitor Item	Contents
PUSH SW	Indicates [ON/OFF] condition of push switch.
UNLK SEN -DR	Indicates [ON/OFF] condition of unlock sensor.
VEH SPEED 1	Indicates [Km/h] condition of vehicle speed signal from combination meter.
KEY CYL SW-TR	NOTE: This item is displayed, but cannot be monitored.
TR CANCEL SW	Indicates [ON/OFF] condition of trunk lid opener cancel switch.
TR/BD OPEN SW	Indicates [ON/OFF] condition of trunk lid opener switch.
TRNK/HAT MNTR	Indicates [ON/OFF] condition of trunk room lamp switch.
RKE-TR/BD	Indicates [ON/OFF] condition of trunk open signal from Intelligent Key remote controller button.
TRUNK/GLASS HATCH	This test is able to check trunk lid opener actuator open operation.

ACTIVE TEST

Test item	Description
TRUNK/GLASS HATCH	This test is able to check trunk lid opener actuator open operation. This actuator opens when "OPEN" on CONSULT-III screen is touched.

THEFT ALM

THEFT ALM : CONSULT-III Function (BCM - THEFT)

INFOID:0000000005890805

DATA MONITOR

DIAGNOSIS SYSTEM (BCM)

< SYSTEM DESCRIPTION >

Monitored Item	Description
REQ SW-DR	Indicates [ON/OFF] condition of door request switch (driver side).
REQ SW-AS	Indicates [ON/OFF] condition of door request switch (passenger side).
REQ SW-BD/TR	Indicates [ON/OFF] condition of trunk opener request switch.
PUSH SW	Indicates [ON/OFF] condition of push-button ignition switch
UNLK SEN-DR	Indicates [ON/OFF] condition of driver door UNLOCK status.
KEY SW -SLOT	Indicates [ON/OFF] condition of key slot.
DOOR SW-DR	Indicates [ON/OFF] condition of front door switch LH.
DOOR SW-AS	Indicates [ON/OFF] condition of front door switch RH.
DOOR SW-RR	Indicates [ON/OFF] condition of rear door switch RH.
DOOR SW-RL	Indicates [ON/OFF] condition of rear door switch LH.
DOOR SW-BK	This is displayed even when it is not equipped.
CDL LOCK SW	Indicates [ON/OFF] condition of lock signal from door lock/unlock switch LH and RH.
CDL UNLOCK SW	Indicates [ON/OFF] condition of unlock signal from door lock/unlock switch LH and RH.
KEY CYL LK-SW	Indicates [ON/OFF] condition of lock signal from front door key cylinder switch.
KEY CYL UN-SW	Indicates [ON/OFF] condition of unlock signal from front door key cylinder switch.
KEY CYL SW-TR	This is displayed even when it is not equipped.
TR/BD OPEN SW	Indicates [ON/OFF] condition of trunk lid opener switch.
TRNK/HAT MNTR	Indicates [ON/OFF] condition of trunk room lamp switch.
RKE-LOCK	Indicates [ON/OFF] condition of LOCK signal from Intelligent Key.
RKE-UNLOCK	Indicates [ON/OFF] condition of UNLOCK signal from Intelligent Key.
RKE-TR/BD	Indicates [ON/OFF] condition of TRUNK OPEN signal from Intelligent Key.

WORK SUPPORT

Test Item	Description
SECURITY ALARM SET	This mode is able to confirm and change security alarm ON-OFF setting.
THEFT ALM TRG	The switch which triggered vehicle security alarm is recorded. This mode is able to confirm and erase the record of vehicle security alarm. The trigger data can be erased by touching "CLEAR" on CONSULT-III screen.

ACTIVE TEST

Test Item	Description
THEFT IND	This test is able to check security indicator lamp operation. The lamp will be turned on when "ON" on CONSULT-III screen is touched.
VEHICLE SECURITY HORN	This test is able to check vehicle security horn operation. The horns will be activated for 0.5 seconds after "ON" on CONSULT-III screen is touched.
HEADLAMP(HI)	This test is able to check vehicle security lamp operation. The headlamps will be activated for 0.5 seconds after "ON" on CONSULT-III screen is touched.
FLASHER	This test is able to check vehicle security hazard lamp operation. The hazard lamps will be activated after "ON" on CONSULT-III screen is touched.

RETAINED PWR

RETAINED PWR : CONSULT-III Function (BCM - RETAINED PWR)

INFOID:000000005890807

Data monitor

DIAGNOSIS SYSTEM (BCM)

< SYSTEM DESCRIPTION >

Monitor Item	Description
DOOR SW-DR	Indicates [ON/OFF] condition of driver side door switch.
DOOR SW-AS	Indicates [ON/OFF] condition of passenger side door switch.

SIGNAL BUFFER

SIGNAL BUFFER : CONSULT-III Function (BCM - SIGNAL BUFFER)

INFOID:000000005656202

DATA MONITOR

Monitor item [UNIT]	Description
PUSH SW [Off/On]	Displays the status of the push-button ignition switch (push switch) judged by BCM.

ACTIVE TEST

Test item	Operation	Description
OIL PRESSURE SW	Off	OFF
	On	BCM transmits the oil pressure switch signal to the unified meter and A/C amp. via CAN communication, which illuminates the oil pressure warning lamp in the combination meter.

AIR PRESSURE MONITOR

AIR PRESSURE MONITOR : CONSULT-III Function (BCM - AIR PRESSURE MONITOR)

INFOID:000000005890815

WORK SUPPORT MODE

ID Read

The registered ID number is displayed.

ID Regist

Refer to [WT-23, "ID REGISTRATION PROCEDURE : Special Repair Requirement"](#).

SELF-DIAG RESULTS MODE

Operation Procedure

Refer to [BCS-73, "DTC Index"](#).

DATA MONITOR MODE

Screen of data monitor mode is displayed.

NOTE:

When malfunction is detected, CONSULT-III perform REAL-TIME DIAGNOSIS. Also, any malfunction detected while in this mode will be displayed at real time.

Monitor item (Unit)	Remark
AIR PRESS FL (kPa/kg/cm ² /Psi)	Tire pressure
AIR PRESS FR (kPa/kg/cm ² /Psi)	
AIR PRESS RR (kPa/kg/cm ² /Psi)	
AIR PRESS RL (kPa/kg/cm ² /Psi)	
ID REGST FL1 (Green/Red)	Registration ID
ID REGST FR1 (Green/Red)	
ID REGST RR1 (Green/Red)	
ID REGST RL1 (Green/Red)	

A
B
C
D
E
F
G
H
I
J
K
L
N
O
P

BCS

DIAGNOSIS SYSTEM (BCM)

< SYSTEM DESCRIPTION >

Monitor item (Unit)	Remark
WARNING LAMP (On/Off)	Low tire pressure warning lamp
BUZZER (On/Off)	Buzzer in combination meter

NOTE:

Before performing the self-diagnosis, be sure to register the ID, or erase the actual malfunction location may be different from that displayed on CONSULT-III.

ACTIVE TEST MODE

NOTE:

Before performing the self-diagnosis, be sure to register the ID, or erase the actual malfunction may be different from that displayed on CONSULT-III.

TEST ITEM LIST

Test item	Content
WARNING LAMP	This test is able to check to check that the low tire pressure warning lamp turns on.
ID REGIST WARNING	This test is able to check to check that the buzzer sounds or the low tire pressure warning lamp turns on.
FLASHER	This test is able to check to check that each turn signal lamp turns on.
HORN	This test is able to check to check that the horn sounds.

U1000 CAN COMM

< DTC/CIRCUIT DIAGNOSIS >

DTC/CIRCUIT DIAGNOSIS

U1000 CAN COMM

Description

INFOID:0000000005656205

CAN (Controller Area Network) is a serial communication line for real time applications. It is an on-vehicle multiplex communication line with high data communication speed and excellent error detection ability. Modern vehicle is equipped with many electronic control unit, and each control unit shares information and links with other control units during operation (not independent). In CAN communication, control units are connected with 2 communication lines (CAN H-line, CAN L-line) allowing a high rate of information transmission with less wiring. Each control unit transmits/receives data but selectively reads required data only.
CAN Communication Signal Chart. Refer to [LAN-27, "CAN Communication Signal Chart"](#).

DTC Logic

INFOID:0000000005656206

DTC DETECTION LOGIC

DTC	CONSULT-III display description	DTC Detection Condition	Possible cause
U1000	CAN COMM	When BCM cannot communicate CAN communication signal continuously for 2 seconds or more.	CAN communication system

Diagnosis Procedure

INFOID:0000000005656207

1.PERFORM SELF DIAGNOSTIC

1. Turn ignition switch ON and wait for 2 seconds or more.
2. Check "Self Diagnostic Result".

Is DTC "U1000" displayed?

- YES >> Refer to [LAN-18, "Trouble Diagnosis Flow Chart"](#).
NO >> Refer to [GI-38, "Intermittent Incident"](#).

A
B
C
D
E
F
G
H
I
J
K
L

BCS

N
O
P

U1010 CONTROL UNIT (CAN)

< DTC/CIRCUIT DIAGNOSIS >

U1010 CONTROL UNIT (CAN)

DTC Logic

INFOID:000000005656208

DTC DETECTION LOGIC

DTC	CONSULT-III display description	DTC Detection Condition	Possible cause
U1010	CONTROL UNIT(CAN)	BCM detected internal CAN communication circuit malfunction.	BCM

Diagnosis Procedure

INFOID:000000005656209

1.REPLACE BCM

When DTC "U1010" is detected, replace BCM.

>> Replace BCM. Refer to [BCS-78. "Exploded View"](#).

U0415 VEHICLE SPEED

< DTC/CIRCUIT DIAGNOSIS >

U0415 VEHICLE SPEED

Description

INFOID:000000005656210

U0415 is displayed if any unusual condition is present in the reception status of the vehicle speed signal from the ABS actuator and electric unit (control unit).

DTC Logic

INFOID:000000005656211

DTC DETECTION LOGIC

DTC	CONSULT-III display description	DTC Detection Condition	Probable cause
U0415	VEHICLE SPEED	When the vehicle speed signal received from the ABS actuator and electric unit (control unit) remains abnormal for 2 seconds or more.	<ul style="list-style-type: none">• ABS actuator and electric unit (control unit)• BCM

DTC CONFIRMATION PROCEDURE

1. DTC CONFIRMATION

1. Erase the DTC.
2. Turn ignition switch OFF.
3. Perform the "Self Diagnostic Result" of CONSULT-III, when passed 2 seconds or more after the ignition switch is turned ON.

Is any DTC detected?

- YES >> Refer to [BCS-35, "Diagnosis Procedure"](#).
NO >> INSPECTION END

Diagnosis Procedure

INFOID:000000005656212

1. ABS ACTUATOR AND ELECTRIC UNIT (CONTROL UNIT) SELF-DIAG RESULTS

Perform "Self-Diagnostic Result" of ABS actuator and electric unit (control unit) with CONSULT-III. Refer to [BRC-26, "CONSULT-III Function"](#).

Is any DTC detected?

- YES >> Repair or replace the malfunctioning part.
NO >> Replace BCM. Refer to [BCS-78, "Exploded View"](#).

A
B
C
D
E
F
G
H
I
J
K
L

BCS

N
O
P

B2562 LOW VOLTAGE

< DTC/CIRCUIT DIAGNOSIS >

B2562 LOW VOLTAGE

DTC Logic

INFOID:000000005656213

DTC DETECTION LOGIC

DTC	CONSULT-III display description	DTC Detection Condition	Possible cause
B2562	LOW VOLTAGE	When the power supply voltage to BCM remains less than 8.8 V for 120 seconds or more	Harness or connector (power supply circuit)

DTC CONFIRMATION PROCEDURE

1. DTC CONFIRMATION

1. Erase DTC.
2. Turn ignition switch OFF.
3. Perform the "Self Diagnostic Result" of CONSULT-III, when passed 120 seconds or more after the ignition switch is turned ON.

Is any DTC detected?

- YES >> Refer to [BCS-36, "Diagnosis Procedure"](#).
NO >> INSPECTION END

Diagnosis Procedure

INFOID:000000005656214

1. CHECK POWER SUPPLY CIRCUIT

Check BCM power supply circuit. Refer to [BCS-37, "Diagnosis Procedure"](#).

Is the circuit normal?

- YES >> Replace BCM. Refer to [BCS-78, "Exploded View"](#).
NO >> Repair the malfunctioning part.

POWER SUPPLY AND GROUND CIRCUIT

< DTC/CIRCUIT DIAGNOSIS >

POWER SUPPLY AND GROUND CIRCUIT

Diagnosis Procedure

INFOID:000000005656215

1.CHECK FUSE AND FUSIBLE LINK

Check that the following fuse and fusible link are not blown.

Signal name	Fuse and fusible link No.
Battery power supply	K
	10

Is the fuse fusing?

YES >> Replace the blown fuse or fusible link after repairing the affected circuit if a fuse or fusible link is blown.

NO >> GO TO 2.

2.CHECK POWER SUPPLY CIRCUIT

1. Turn ignition switch OFF.
2. Disconnect BCM connectors.
3. Check voltage between BCM harness connector and ground.

Terminals		Voltage (Approx.)
(+)	(-)	
BCM		Ground Battery voltage
Connector	Terminal	
M118	1	
M119	11	

Is the measurement value normal?

YES >> GO TO 3.

NO >> Repair harness or connector.

3.CHECK GROUND CIRCUIT

Check continuity between BCM harness connector and ground.

BCM		Ground	Continuity
Connector	Terminal		
M119	13		Existed

Does continuity exist?

YES >> INSPECTION END

NO >> Repair harness or connector.

A
B
C
D
E
F
G
H
I
J
K
L
N
O
P

BCS

COMBINATION SWITCH INPUT CIRCUIT

< DTC/CIRCUIT DIAGNOSIS >

COMBINATION SWITCH INPUT CIRCUIT

Diagnosis Procedure

INFOID:000000005656216

1. CHECK INPUT 1 - 5 SYSTEM CIRCUIT FOR OPEN

1. Turn the ignition switch OFF.
2. Disconnect the BCM and combination switch connectors.
3. Check continuity between BCM harness connector and combination switch harness connector.

System	BCM		Combination switch		Continuity
	Connector	Terminal	Connector	Terminal	
INPUT 1	M122	107	M33	11	Existed
INPUT 2		109		9	
INPUT 3		88		7	
INPUT 4		108		10	
INPUT 5		87		13	

Does continuity exist?

YES >> GO TO 2.

NO >> Repair the harnesses or connectors.

2. CHECK INPUT 1 - 5 SYSTEM CIRCUIT FOR SHORT

Check for continuity between BCM harness connector and ground.

System	BCM		Ground	Continuity
	Connector	Terminal		
INPUT 1	M122	107	Ground	Not existed
INPUT 2		109		
INPUT 3		88		
INPUT 4		108		
INPUT 5		87		

Does continuity exist?

YES >> Repair the harnesses or connectors.

NO >> GO TO 3.

3. CHECK BCM OUTPUT VOLTAGE

1. Connect the BCM connector.
2. Check voltage between BCM harness connector and ground.

System	Terminals		Voltage (Approx.)
	(+)	(-)	
	BCM		
	Connector	Terminal	
INPUT 1	M122	107	Ground
INPUT 2		109	
INPUT 3		88	
INPUT 4		108	
INPUT 5		87	

Is the measurement value normal?

YES >> GO TO 4.

NO >> Replace BCM. Refer to [BCS-78. "Exploded View"](#).

COMBINATION SWITCH INPUT CIRCUIT

< DTC/CIRCUIT DIAGNOSIS >

4. CHECK BCM INPUT SIGNAL

1. Connect the combination switch connector.
2. Turn ON any switch in the system that is malfunctioning.
3. Check voltage between BCM harness connector and ground.

System	Terminals		Voltage (Approx.)
	(+)	(-)	
	BCM		
	Connector	Terminal	
INPUT 1	M122	107	Ground Refer to BCS-42 . "Reference Value".
INPUT 2		109	
INPUT 3		88	
INPUT 4		108	
INPUT 5		87	

Is the measurement value normal when any of the switches is turned ON?

- YES >> Replace BCM. Refer to [BCS-78](#). "Exploded View".
NO >> Replace the combination switch.

A
B
C
D
E
F
G
H
I
J
K
L

BCS

N
O
P

COMBINATION SWITCH OUTPUT CIRCUIT

< DTC/CIRCUIT DIAGNOSIS >

COMBINATION SWITCH OUTPUT CIRCUIT

Diagnosis Procedure

INFOID:000000005656217

1. CHECK OUTPUT 1 - 5 SYSTEM CIRCUIT FOR OPEN

1. Turn the ignition switch OFF.
2. Disconnect the BCM and combination switch connectors.

NOTE:

BCM connector disconnects M123 only.

3. Check continuity between BCM harness connector and combination switch harness connector.

System	BCM		Combination switch		Continuity
	Connector	Terminal	Connector	Terminal	
OUTPUT 1	M123	143	M33	12	Existed
OUTPUT 2		144		14	
OUTPUT 3		145		5	
OUTPUT 4		146		2	
OUTPUT 5		142		8	

Does continuity exist?

YES >> GO TO 2.

NO >> Repair the harnesses or connectors.

2. CHECK OUTPUT 1 - 5 SYSTEM CIRCUIT FOR SHORT

Check for continuity between BCM harness connector and ground.

System	BCM		Ground	Continuity
	Connector	Terminal		
OUTPUT 1	M123	143	Ground	Not existed
OUTPUT 2		144		
OUTPUT 3		145		
OUTPUT 4		146		
OUTPUT 5		142		

Does continuity exist?

YES >> Repair the harnesses or connectors.

NO >> GO TO 3.

3. CHECK COMBINATION SWITCH INTERNAL CIRCUIT

1. Connect the combination switch connector.
2. Turn ON any switch in the system that is malfunctioning.
3. Check voltage between combination switch harness connector and ground.

NOTE:

Check that the combination switch outputs a signal from combination switch input system.

COMBINATION SWITCH OUTPUT CIRCUIT

< DTC/CIRCUIT DIAGNOSIS >

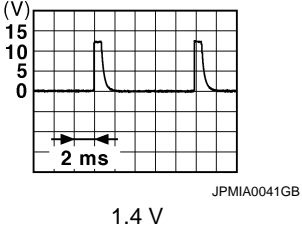
System	Terminals		Value (Approx.)
	(+)	(-)	
	Combination switch		
	Connector	Terminal	
OUTPUT 1	M33	12	
OUTPUT 2		14	
OUTPUT 3		5	
OUTPUT 4		2	
OUTPUT 5		8	

Is the measurement value normal when any of the switches is turned ON?

- YES >> Replace BCM. Refer to [BCS-78, "Exploded View"](#).
- NO >> Replace the combination switch.

A
B
C
D
E
F
G
H
I
J
K
L
N
O
P

BCS

BCM (BODY CONTROL MODULE)

< ECU DIAGNOSIS INFORMATION >

ECU DIAGNOSIS INFORMATION

BCM (BODY CONTROL MODULE)

Reference Value

INFOID:000000005656218

VALUES ON THE DIAGNOSIS TOOL

CONSULT-III MONITOR ITEM

Monitor Item	Condition	Value/Status
FR WIPER HI	Other than front wiper switch HI	Off
	Front wiper switch HI	On
FR WIPER LOW	Other than front wiper switch LO	Off
	Front wiper switch LO	On
FR WASHER SW	Front washer switch OFF	Off
	Front washer switch ON	On
FR WIPER INT	Other than front wiper switch INT/AUTO	Off
	Front wiper switch INT/AUTO	On
FR WIPER STOP	Front wiper is not in STOP position	Off
	Front wiper is in STOP position	On
INT VOLUME	Wiper volume dial is in a dial position 1 - 7	Wiper volume dial position
TURN SIGNAL R	Other than turn signal switch RH	Off
	Turn signal switch RH	On
TURN SIGNAL L	Other than turn signal switch LH	Off
	Turn signal switch LH	On
TAIL LAMP SW	Other than lighting switch 1ST and 2ND	Off
	Lighting switch 1ST or 2ND	On
HI BEAM SW	Other than lighting switch HI	Off
	Lighting switch HI	On
HEAD LAMP SW 1	Other than lighting switch 2ND	Off
	Lighting switch 2ND	On
HEAD LAMP SW 2	Other than lighting switch 2ND	Off
	Lighting switch 2ND	On
PASSING SW	Other than lighting switch PASS	Off
	Lighting switch PASS	On
AUTO LIGHT SW	Other than lighting switch AUTO	Off
	Lighting switch AUTO	On
FR FOG SW	Front fog lamp switch OFF	Off
	Front fog lamp switch ON	On
RR FOG SW	NOTE: The item is indicated, but not monitored.	Off
DOOR SW-DR	Driver door closed	Off
	Driver door opened	On
DOOR SW-AS	Passenger door closed	Off
	Passenger door opened	On
DOOR SW-RR	NOTE: The item is indicated, but not monitored.	Off

BCM (BODY CONTROL MODULE)

< ECU DIAGNOSIS INFORMATION >

Monitor Item	Condition	Value/Status	
DOOR SW-RL	NOTE: The item is indicated, but not monitored.	Off	A
DOOR SW-BK	NOTE: The item is indicated, but not monitored.	Off	B
CDL LOCK SW	Other than power door lock switch LOCK	Off	C
	Power door lock switch LOCK	On	
CDL UNLOCK SW	Other than power door lock switch UNLOCK	Off	D
	Power door lock switch UNLOCK	On	
KEY CYL LK-SW	Other than driver door key cylinder LOCK position	Off	E
	Driver door key cylinder LOCK position	On	
KEY CYL UN-SW	Other than driver door key cylinder UNLOCK position	Off	F
	Driver door key cylinder UNLOCK position	On	
KEY CYL SW-TR	NOTE: The item is indicated, but not monitored.	Off	G
HAZARD SW	Hazard switch is OFF	Off	H
	Hazard switch is ON	On	
REAR DEF SW	NOTE: The item is indicated, but not monitored.	Off	I
H/L WASH SW	NOTE: The item is indicated, but not monitored.	Off	J
TR CANCEL SW	Trunk lid opener cancel switch OFF	Off	K
	Trunk lid opener cancel switch ON	On	
TR/BD OPEN SW	Trunk lid opener switch OFF	Off	L
	While the trunk lid opener switch is turned ON	On	
TRNK/HAT MNTR	Trunk lid closed	Off	J
	Trunk lid opened	On	
RKE-LOCK	LOCK button of the Intelligent Key is not pressed	Off	K
	LOCK button of the Intelligent Key is pressed	On	
RKE-UNLOCK	UNLOCK button of the Intelligent Key is not pressed	Off	L
	UNLOCK button of the Intelligent Key is pressed	On	
RKE-TR/BD	TRUNK OPEN button of the Intelligent Key is not pressed	Off	BCS
	TRUNK OPEN button of the Intelligent Key is pressed	On	
RKE-PANIC	PANIC button of the Intelligent Key is not pressed	Off	N
	PANIC button of the Intelligent Key is pressed	On	
RKE-P/W OPEN	UNLOCK button of the Intelligent Key is not pressed	Off	O
	UNLOCK button of the Intelligent Key is pressed and held	On	
RKE-MODE CHG	LOCK/UNLOCK button of the Intelligent Key is not pressed and held simultaneously	Off	P
	LOCK/UNLOCK button of the Intelligent Key is pressed and held simultaneously	On	
OPTICAL SENSOR	Bright outside of the vehicle	Close to 5 V	P
	Dark outside of the vehicle	Close to 0 V	
REQ SW -DR	Driver door request switch is not pressed	Off	
	Driver door request switch is pressed	On	
REQ SW -AS	Passenger door request switch is not pressed	Off	
	Passenger door request switch is pressed	On	
REQ SW -RR	NOTE: The item is indicated, but not monitored.	Off	

BCM (BODY CONTROL MODULE)

< ECU DIAGNOSIS INFORMATION >

Monitor Item	Condition	Value/Status
REQ SW -RL	NOTE: The item is indicated, but not monitored.	Off
REQ SW -BD/TR	Trunk lid opener request switch is not pressed	Off
	Trunk lid opener request switch is pressed	On
PUSH SW	Push-button ignition switch (push switch) is not pressed	Off
	Push-button ignition switch (push switch) is pressed	On
IGN RLY2 -F/B	Ignition switch in OFF or ACC position	Off
	Ignition switch in ON position	On
ACC RLY -F/B	NOTE: The item is indicated, but not monitored.	Off
CLUCH SW	The clutch pedal is not depressed	Off
	The clutch pedal is depressed	On
BRAKE SW 1	The brake pedal is depressed when No. 7 fuse is blown	Off
	The brake pedal is not depressed when No. 7 fuse is blown, or No. 7 fuse is normal	On
BRAKE SW 2	The brake pedal is not depressed	Off
	The brake pedal is depressed	On
DETE/CANCL SW	<ul style="list-style-type: none"> • Selector lever in P position (Except M/T models) • The clutch pedal is depressed (M/T models) 	Off
	<ul style="list-style-type: none"> • Selector lever in any position other than P (Except M/T models) • The clutch pedal is not depressed (M/T models) 	On
SFT PN/N SW	Selector lever in any position other than P and N	Off
	Selector lever in P or N position	On
S/L -LOCK	Steering is unlocked	Off
	Steering is locked	On
S/L -UNLOCK	Steering is locked	Off
	Steering is unlocked	On
S/L RELAY-F/B	Ignition switch in OFF or ACC position	Off
	Ignition switch in ON position	On
UNLK SEN -DR	Driver door is unlocked	Off
	Driver door is locked	On
PUSH SW -IPDM	Push-button ignition switch (push-switch) is not pressed	Off
	Push-button ignition switch (push-switch) is pressed	On
IGN RLY1 -F/B	Ignition switch in OFF or ACC position	Off
	Ignition switch in ON position	On
DETE SW -IPDM	Selector lever in any position other than P	Off
	Selector lever in P position	On
SFT PN -IPDM	<ul style="list-style-type: none"> • Selector lever in any position other than P and N (Except M/T models) • The clutch pedal is not depressed (M/T models) 	Off
	<ul style="list-style-type: none"> • Selector lever in P or N position • The clutch pedal is depressed 	On
SFT P -MET	Selector lever in any position other than P	Off
	Selector lever in P position	On
SFT N -MET	Selector lever in any position other than N	Off
	Selector lever in N position	On

BCM (BODY CONTROL MODULE)

< ECU DIAGNOSIS INFORMATION >

Monitor Item	Condition	Value/Status	
ENGINE STATE	Engine stopped	Stop	A
	While the engine stalls	Stall	
	At engine cranking	Crank	B
	Engine running	Run	
S/L LOCK-IPDM	Steering is unlocked	Off	
	Steering is locked	On	C
S/L UNLK-IPDM	Steering is locked	Off	
	Steering is unlocked	On	D
S/L RELAY-REQ	Steering lock system is not the LOCK condition and the changing condition from LOCK to UNLOCK	Off	
	Steering lock system are not the LOCK condition or the changing condition from LOCK to UNLOCK	On	E
VEH SPEED 1	While driving	Equivalent to speedometer reading	F
VEH SPEED 2	While driving	Equivalent to speedometer reading	
DOOR STAT-DR	Driver door is locked	LOCK	G
	Wait with selective UNLOCK operation (60 seconds)	READY	
	Driver door is unlocked	UNLOCK	
DOOR STAT-AS	Passenger door is locked	LOCK	H
	Wait with selective UNLOCK operation (60 seconds)	READY	
	Passenger door is unlocked	UNLOCK	
ID OK FLAG	Steering is locked	Reset	I
	Steering is unlocked	Set	
PRMT ENG STRT	The engine start is prohibited	Reset	J
	The engine start is permitted	Set	
PRMT RKE STRT	NOTE: The item is indicated, but not monitored.	Reset	K
KEY SW -SLOT	The Intelligent Key is not inserted into key slot	Off	
	The Intelligent Key is inserted into key slot	On	L
RKE OPE COUN1	During the operation of the Intelligent Key	Operation frequency of the Intelligent Key	
RKE OPE COUN2	NOTE: The item is indicated, but not monitored.	—	BCS
CONFIRM ID ALL	The key ID that the key slot receives is not recognized by any key ID registered to BCM.	Yet	
	The key ID that the key slot receives is recognized by any key ID registered to BCM.	Done	N
CONFIRM ID4	The key ID that the key slot receives is not recognized by the fourth key ID registered to BCM.	Yet	O
	The key ID that the key slot receives is recognized by the fourth key ID registered to BCM.	Done	
CONFIRM ID3	The key ID that the key slot receives is not recognized by the third key ID registered to BCM.	Yet	P
	The key ID that the key slot receives is recognized by the third key ID registered to BCM.	Done	

BCM (BODY CONTROL MODULE)

< ECU DIAGNOSIS INFORMATION >

Monitor Item	Condition	Value/Status
CONFIRM ID2	The key ID that the key slot receives is not recognized by the second key ID registered to BCM.	Yet
	The key ID that the key slot receives is recognized by the second key ID registered to BCM.	Done
CONFIRM ID1	The key ID that the key slot receives is not recognized by the first key ID registered to BCM.	Yet
	The key ID that the key slot receives is recognized by the first key ID registered to BCM.	Done
TP 4	The ID of fourth Intelligent Key is not registered to BCM	Yet
	The ID of fourth Intelligent Key is registered to BCM	Done
TP 3	The ID of third Intelligent Key is not registered to BCM	Yet
	The ID of third Intelligent Key is registered to BCM	Done
TP 2	The ID of second Intelligent Key is not registered to BCM	Yet
	The ID of second Intelligent Key is registered to BCM	Done
TP 1	The ID of first Intelligent Key is not registered to BCM	Yet
	The ID of first Intelligent Key is registered to BCM	Done
AIR PRESS FL	Ignition switch ON (Only when the signal from the transmitter is received)	Air pressure of front LH tire
AIR PRESS FR	Ignition switch ON (Only when the signal from the transmitter is received)	Air pressure of front RH tire
AIR PRESS RR	Ignition switch ON (Only when the signal from the transmitter is received)	Air pressure of rear RH tire
AIR PRESS RL	Ignition switch ON (Only when the signal from the transmitter is received)	Air pressure of rear LH tire
ID REGST FL1	ID of front LH tire transmitter is registered	Done
	ID of front LH tire transmitter is not registered	Yet
ID REGST FR1	ID of front RH tire transmitter is registered	Done
	ID of front RH tire transmitter is not registered	Yet
ID REGST RR1	ID of rear RH tire transmitter is registered	Done
	ID of rear RH tire transmitter is not registered	Yet
ID REGST RL1	ID of rear LH tire transmitter is registered	Done
	ID of rear LH tire transmitter is not registered	Yet
WARNING LAMP	Tire pressure indicator OFF	Off
	Tire pressure indicator ON	On
BUZZER	Tire pressure warning alarm is not sounding	Off
	Tire pressure warning alarm is sounding	On

BCM (BODY CONTROL MODULE)

< ECU DIAGNOSIS INFORMATION >

TERMINAL LAYOUT

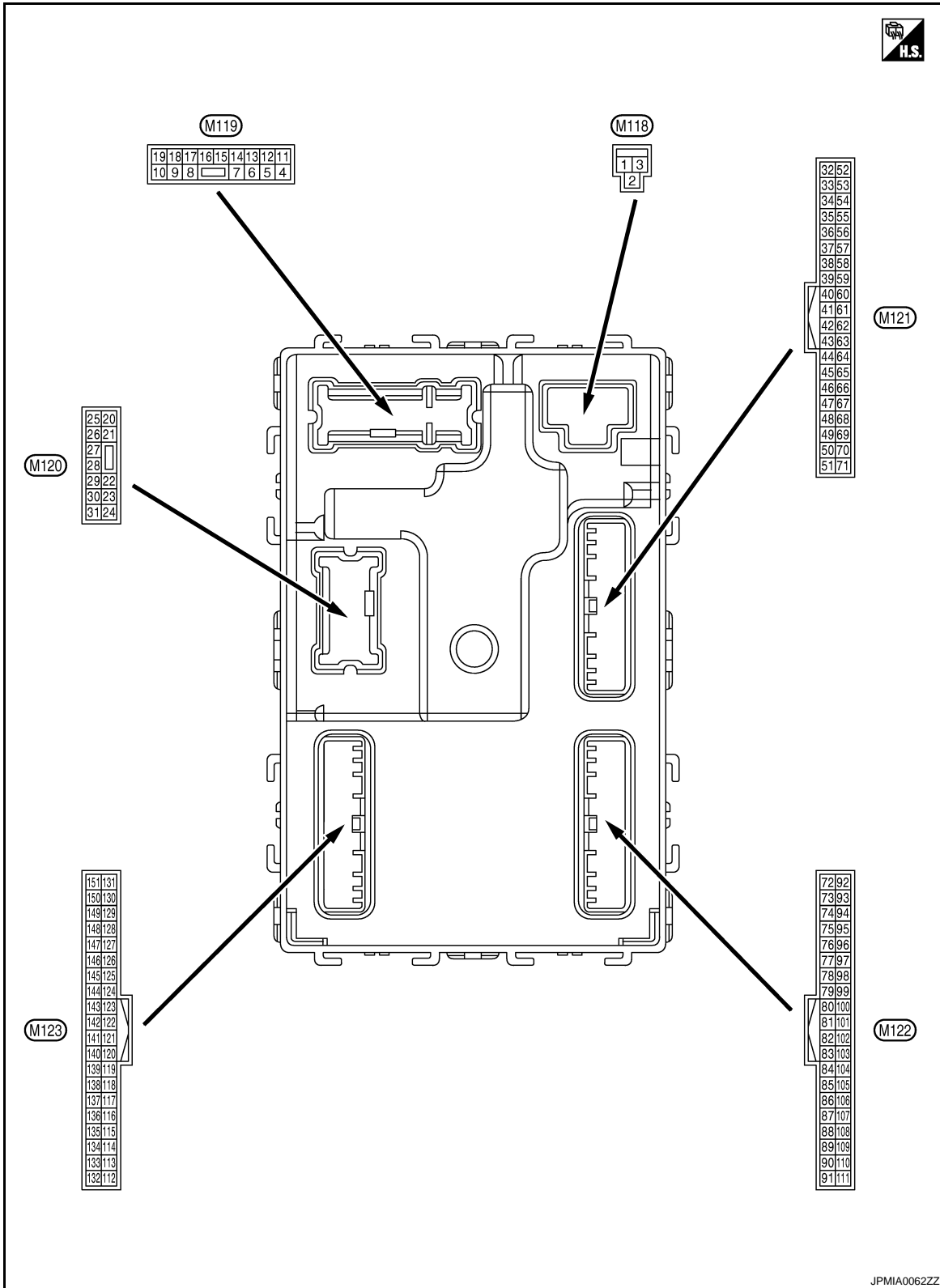

PHYSICAL VALUES

A
B
C
D
E
F
G
H
I
J
K
L
N
O
P

BCS

BCM (BODY CONTROL MODULE)

< ECU DIAGNOSIS INFORMATION >

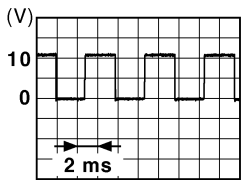
Terminal No. (Wire color)		Description		Condition		Value (Approx.)
		Signal name	Input/ Output			
+	-					
1 (L)	Ground	Battery power supply	Input	Ignition switch OFF		Battery voltage
2 (Y)	Ground	P/W power supply (BAT)	Output	Ignition switch OFF		12 V
3 (BG)	Ground	P/W power supply (RAP)	Output	Ignition switch ON		12 V
4 (LG)	Ground	Interior room lamp power supply	Output	Interior room lamp battery saver is activated. (Cuts the interior room lamp power supply)		0 V
				Interior room lamp battery saver is not activated. (Outputs the interior room lamp power supply)		12 V
5 (P)	Ground	Passenger door UN- LOCK	Output	Passenger door	UNLOCK (Actuator is activated)	12 V
					Other than UNLOCK (Actuator is not activated)	0 V
7 (SB)	Ground	Step lamp	Output	Step lamp	ON	0 V
					OFF	12 V
8 (V)	Ground	All doors, fuel lid LOCK	Output	All doors, fuel lid	LOCK (Actuator is activated)	12 V
					Other than LOCK (Actuator is not activated)	0 V
9 (G)	Ground	Driver door, fuel lid UNLOCK	Output	Driver door, fuel lid	UNLOCK (Actuator is activated)	12 V
					Other than UNLOCK (Actuator is not activated)	0 V
11 (R)	Ground	Battery power supply	Input	Ignition switch OFF		Battery voltage
13 (B)	Ground	Ground	—	Ignition switch ON		0 V
14 (W)	Ground	Push-button ignition switch illumination ground	Output	Tail lamp	OFF	0 V
					ON	<p style="text-align: center;">NOTE: When the illumination brightening/dimming level is in the neutral position.</p> 
15 (BG)	Ground	ACC indicator lamp	Output	Ignition switch	OFF (LOCK indicator is not illuminated)	Battery voltage
					ACC	0 V

JSNIA0010GB

BCM (BODY CONTROL MODULE)

< ECU DIAGNOSIS INFORMATION >

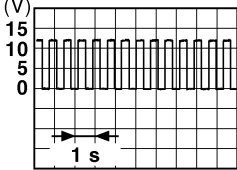
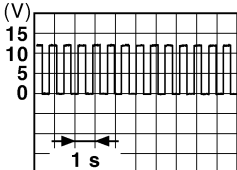
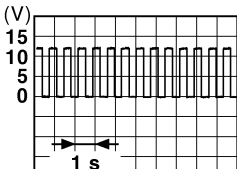
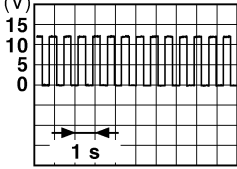
Terminal No. (Wire color)		Description		Condition	Value (Approx.)	
		Signal name	Input/ Output			
+	-					
17 (W)	Ground	Turn signal RH (Front)	Output	Ignition switch ON	Turn signal switch OFF	0 V
					Turn signal switch RH	 <small>PKID0926E</small>
18 (BG)	Ground	Turn signal LH (Front)	Output	Ignition switch ON	Turn signal switch OFF	0 V
					Turn signal switch LH	 <small>PKID0926E</small>
19 (V)	Ground	Room lamp timer control	Output	Interior room lamp	OFF	12 V
					ON	0 V
20 (V)	Ground	Turn signal RH (Rear)	Output	Ignition switch ON	Turn signal switch OFF	0 V
					Turn signal switch RH	 <small>PKID0926E</small>
23 (L)	Ground	Trunk lid open	Output	Trunk lid	OPEN (Trunk lid opener actuator is activated)	12 V
					Other than OPEN (Trunk lid opener actuator is not activated)	0 V
25 (Y)	Ground	Turn signal LH (Rear)	Output	Ignition switch ON	Turn signal switch OFF	0 V
					Turn signal switch LH	 <small>PKID0926E</small>
30 (P)	Ground	Trunk room lamp	Output	Trunk room lamp	ON	0 V
					OFF	12 V

A
B
C
D
E
F
G
H
I
J
K
L
N
O
P

BCS

BCM (BODY CONTROL MODULE)

< ECU DIAGNOSIS INFORMATION >

Terminal No. (Wire color)		Description		Condition	Value (Approx.)
+	-	Signal name	Input/ Output		
34 (SB)	Ground	Trunk room antenna (-)	Output	Ignition switch OFF	<p style="text-align: right; font-size: small;">JMKIA0062GB</p>
				When Intelligent Key is not in the passenger compart- ment	<p style="text-align: right; font-size: small;">JMKIA0063GB</p>
35 (V)	Ground	Trunk room antenna (+)	Output	Ignition switch OFF	<p style="text-align: right; font-size: small;">JMKIA0062GB</p>
				When Intelligent Key is not in the passenger compart- ment	<p style="text-align: right; font-size: small;">JMKIA0063GB</p>
38 (B)	Ground	Rear bumper anten- na (-)	Output	When the trunk lid opener re- quest switch is operated with ignition switch OFF	<p style="text-align: right; font-size: small;">JMKIA0062GB</p>
				When Intelligent Key is not in the antenna detection area	<p style="text-align: right; font-size: small;">JMKIA0063GB</p>

BCM (BODY CONTROL MODULE)

< ECU DIAGNOSIS INFORMATION >

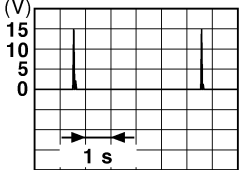
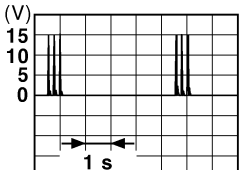
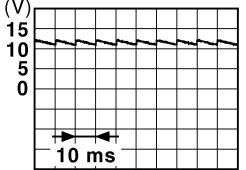
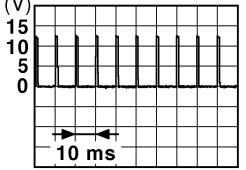
Terminal No. (Wire color)		Description		Condition	Value (Approx.)
		Signal name	Input/ Output		
+	-				
39 (W)	Ground	Rear bumper antenna (+)	Output	When Intelligent Key is in the antenna detection area	 <small>JMKIA0062GB</small>
				When the trunk lid opener request switch is operated with ignition switch OFF	 <small>JMKIA0063GB</small>
47 (Y)	Ground	Ignition relay (IPDM E/R) control	Output	Ignition switch OFF or ACC	12 V
				ON	0 V
50 (G)	Ground	Trunk room lamp switch	Input	Trunk room lamp switch OFF (Trunk lid is closed)	 <small>JPMIA0011GB</small>
				ON (Trunk lid is opened)	0 V
52 (SB)	Ground	Starter relay control	Output	Ignition switch ON (A/T models) When selector lever is in P or N position	12 V
				Ignition switch ON (A/T models) When selector lever is not in P or N position	0 V
				Ignition switch ON (M/T models) When the clutch pedal is depressed	Battery voltage
				Ignition switch ON (M/T models) When the clutch pedal is not depressed	0 V
61 (SB)	Ground	Trunk lid opener request switch	Input	Trunk lid opener request switch ON (Pressed)	0 V
				OFF (Not pressed)	 <small>JPMIA0016GB</small>
64 (P)	Ground	Intelligent Key warning buzzer (Engine room)	Output	Intelligent Key warning buzzer (Engine room) Sounding	0 V
				Not sounding	12 V

A
B
C
D
E
F
G
H
I
J
K
L
N
O
P

BCS

BCM (BODY CONTROL MODULE)

< ECU DIAGNOSIS INFORMATION >

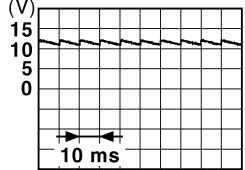
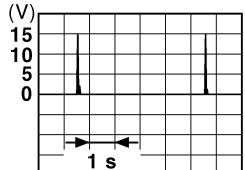
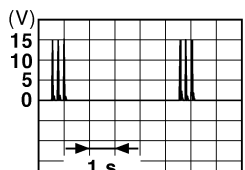
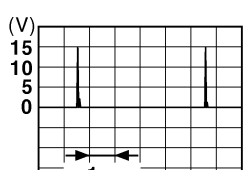
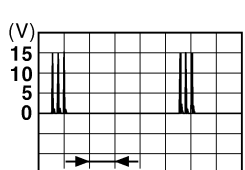
Terminal No. (Wire color)		Description		Condition	Value (Approx.)	
		Signal name	Input/ Output			
+	-					
67 (GR)	Ground	Trunk lid opener switch	Input	Trunk lid open- er switch	Pressed	0 V
					Not pressed	 <p style="text-align: right; font-size: small;">JPMIA0011GB</p>
72 (R)	Ground	Room antenna 2 (-) (Center console)	Output	Ignition switch OFF	When Intelligent Key is in the passenger compart- ment	 <p style="text-align: right; font-size: small;">JMKIA0062GB</p>
					When Intelligent Key is not in the passenger compart- ment	 <p style="text-align: right; font-size: small;">JMKIA0063GB</p>
73 (G)	Ground	Room antenna 2 (+) (Center console)	Output	Ignition switch OFF	When Intelligent Key is in the passenger compart- ment	 <p style="text-align: right; font-size: small;">JMKIA0062GB</p>
					When Intelligent Key is not in the passenger compart- ment	 <p style="text-align: right; font-size: small;">JMKIA0063GB</p>

BCM (BODY CONTROL MODULE)

< ECU DIAGNOSIS INFORMATION >

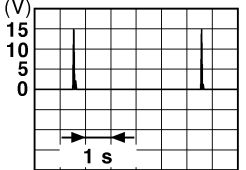
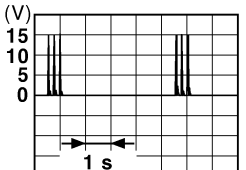
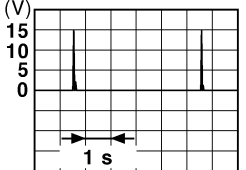
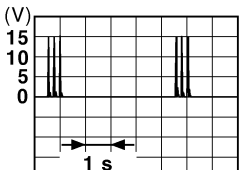
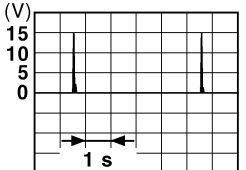
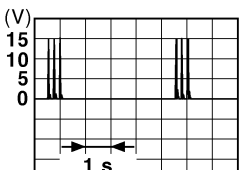
Terminal No. (Wire color)		Description		Condition	Value (Approx.)
		Signal name	Input/ Output		
+	-				
74 (SB)	Ground	Passenger door antenna (-)	Output	When Intelligent Key is in the antenna detection area	 <small>JMKIA0062GB</small>
				When the passenger door request switch is operated with ignition switch OFF	 <small>JMKIA0063GB</small>
75 (BR)	Ground	Passenger door antenna (+)	Output	When Intelligent Key is in the antenna detection area	 <small>JMKIA0062GB</small>
				When the passenger door request switch is operated with ignition switch OFF	 <small>JMKIA0063GB</small>
76 (V)	Ground	Driver door antenna (-)	Output	When Intelligent Key is in the antenna detection area	 <small>JMKIA0062GB</small>
				When the driver door request switch is operated with ignition switch OFF	 <small>JMKIA0063GB</small>

A
B
C
D
E
F
G
H
I
J
K
L
N
O
P

BCS

BCM (BODY CONTROL MODULE)

< ECU DIAGNOSIS INFORMATION >

Terminal No. (Wire color)		Description		Condition	Value (Approx.)
+	-	Signal name	Input/ Output		
77 (LG)	Ground	Driver door antenna (+)	Output	When the driver door request switch is operated with ignition switch OFF	<p style="text-align: right; font-size: small;">JMKIA0062GB</p>
				When Intelligent Key is not in the antenna detection area	<p style="text-align: right; font-size: small;">JMKIA0063GB</p>
78 (Y)	Ground	Room antenna 1 (-) (Instrument panel)	Output	Ignition switch OFF	<p style="text-align: right; font-size: small;">JMKIA0062GB</p>
				When Intelligent Key is not in the passenger compartment	<p style="text-align: right; font-size: small;">JMKIA0063GB</p>
79 (BR)	Ground	Room antenna 1 (+) (Instrument panel)	Output	Ignition switch OFF	<p style="text-align: right; font-size: small;">JMKIA0062GB</p>
				When Intelligent Key is not in the passenger compartment	<p style="text-align: right; font-size: small;">JMKIA0063GB</p>

BCM (BODY CONTROL MODULE)

< ECU DIAGNOSIS INFORMATION >

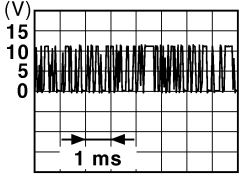
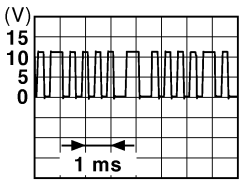
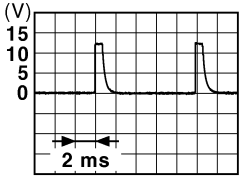
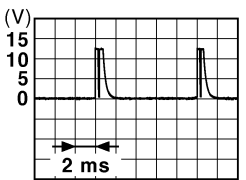
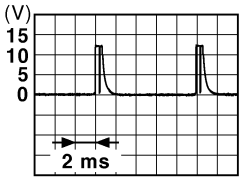
Terminal No. (Wire color)		Description		Condition		Value (Approx.)
+	-	Signal name	Input/ Output			
80 (GR)	Ground	NATS antenna amp.	Input/ Output	During waiting	Ignition switch is pressed while inserting the Intelligent Key into the key slot.	Just after pressing ignition switch. Pointer of tester should move.
81 (W)	Ground	NATS antenna amp.	Input/ Output	During waiting	Ignition switch is pressed while inserting the Intelligent Key into the key slot.	Just after pressing ignition switch. Pointer of tester should move.
82 (V)	Ground	Ignition relay [Fuse block (J/B)] control	Output	Ignition switch	OFF or ACC	0 V
					ON	12 V
83 (Y)	Ground	Remote keyless entry receiver communication	Input/ Output	During waiting		 <p style="text-align: right; font-size: small;">JMKIA0064GB</p>
				When operating either button on the Intelligent Key		 <p style="text-align: right; font-size: small;">JMKIA0065GB</p>
87 (Y)	Ground	Combination switch INPUT 5	Input	Combination switch	All switches OFF (Wiper volume dial 4)	 <p style="text-align: right; font-size: small;">JPMIA0041GB</p> <p style="text-align: center;">1.4 V</p>
					Front fog lamp switch ON (Wiper volume dial 4)	 <p style="text-align: right; font-size: small;">JPMIA0037GB</p> <p style="text-align: center;">1.3 V</p>
					Any of the conditions below with all switches OFF <ul style="list-style-type: none"> • Wiper volume dial 1 • Wiper volume dial 2 • Wiper volume dial 6 • Wiper volume dial 7 	 <p style="text-align: right; font-size: small;">JPMIA0040GB</p> <p style="text-align: center;">1.3 V</p>

A
B
C
D
E
F
G
H
I
J
K
L
N
O
P

BCS

BCM (BODY CONTROL MODULE)

< ECU DIAGNOSIS INFORMATION >

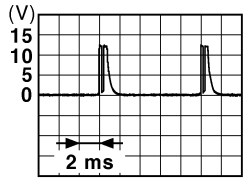
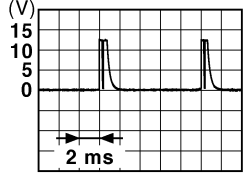
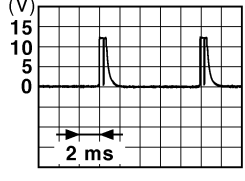
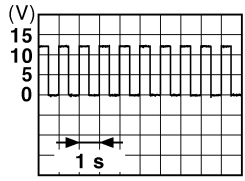
Terminal No. (Wire color)		Description		Condition	Value (Approx.)	
		Signal name	Input/ Output			
+	-					
88 (GR)	Ground	Combination switch INPUT 3	Input	Combination switch	All switches OFF (Wiper volume dial 4)	 <small>JPMIA0041GB</small> 1.4 V
					Lighting switch HI (Wiper volume dial 4)	 <small>JPMIA0036GB</small> 1.3 V
					Lighting switch 2ND (Wiper volume dial 4)	 <small>JPMIA0037GB</small> 1.3 V
					Any of the conditions below with all switches OFF • Wiper volume dial 1 • Wiper volume dial 2 • Wiper volume dial 3	 <small>JPMIA0040GB</small> 1.3 V
89 (BR)	Ground	Push-button ignition switch (Push switch)	Input	Push-button ignition switch (push switch)	Pressed	0 V
					Not pressed	Battery voltage
90 (P)	Ground	CAN-L	Input/ Output	—	—	
91 (L)	Ground	CAN-H	Input/ Output	—	—	
92 (LG)	Ground	Key slot illumination	Output	Key slot illumina- tion	OFF	0 V
					Blinking	 <small>JPMIA0015GB</small> 6.5 V
					ON	12 V

BCM (BODY CONTROL MODULE)

< ECU DIAGNOSIS INFORMATION >

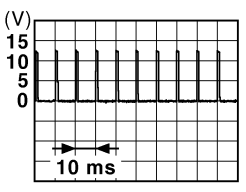
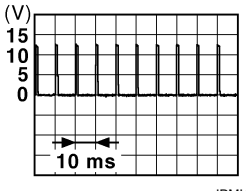

Terminal No. (Wire color)		Description		Condition		Value (Approx.)
		Signal name	Input/ Output			
+	-					
93 (GR)	Ground	ON indicator lamp	Output	Ignition switch	OFF (LOCK indicator is not illuminated)	Battery voltage
					ON	0 V
95 (BG)	Ground	ACC relay control	Output	Ignition switch	OFF	0 V
					ACC or ON	12 V
96 (GR)	Ground	A/T shift selector (Detention switch) power supply	Output	—		12 V
97 (L)	Ground	Steering lock condition No. 1	Input	Steering lock	LOCK status	0 V
					UNLOCK status	12 V
98 (BG)	Ground	Steering lock condition No. 2	Input	Steering lock	LOCK status	12 V
					UNLOCK status	0 V
99 (P) ^{*1} (R) ^{*2}	Ground	Selector lever P position switch	Input	Selector lever	P position	0 V
					Any position other than P	12 V
		ASCD clutch switch (M/T models without ICC)		ASCD clutch switch	OFF (Clutch pedal is depressed)	0 V
					ON (Clutch pedal is not depressed)	12 V
		ICC clutch switch (M/T models with ICC)		ICC clutch switch	OFF (Clutch pedal is depressed)	0 V
					ON (Clutch pedal is not depressed)	12 V
100 (Y)	Ground	Passenger door request switch	Input	Passenger door request switch	ON (Pressed)	0 V
					OFF (Not pressed)	 <p style="text-align: center;">1.0 V</p>
101 (R)	Ground	Driver door request switch	Input	Driver door request switch	ON (Pressed)	0 V
					OFF (Not pressed)	 <p style="text-align: center;">1.0 V</p>
102 (BG)	Ground	Blower fan motor relay control	Output	Ignition switch	OFF or ACC	0 V
					ON	12 V
103 (LG)	Ground	Remote keyless entry receiver power supply	Output	Ignition switch OFF		12 V
106 (W)	Ground	Steering lock unit power supply	Output	Ignition switch	OFF or ACC	12 V
					ON	0 V

A
B
C
D
E
F
G
H
I
J
K
L
N
O
P

BCS

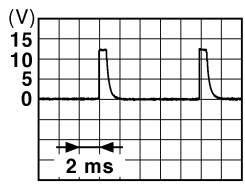
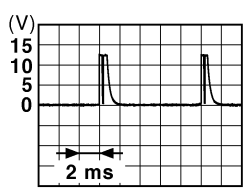

BCM (BODY CONTROL MODULE)

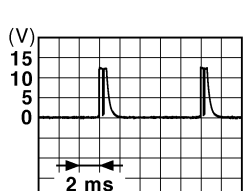
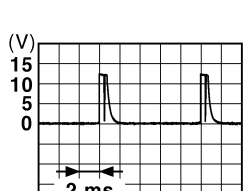
< ECU DIAGNOSIS INFORMATION >

Terminal No. (Wire color)		Description		Condition	Value (Approx.)	
		Signal name	Input/ Output			
+	-					
107 (LG)	Ground	Combination switch INPUT 1	Input	Combination switch (Wiper volume dial 4)	All switches OFF	 <p style="text-align: right;">JPMIA0041GB</p> <p style="text-align: center;">1.4 V</p>
					Turn signal switch LH	 <p style="text-align: right;">JPMIA0037GB</p> <p style="text-align: center;">1.3 V</p>
					Turn signal switch RH	 <p style="text-align: right;">JPMIA0036GB</p> <p style="text-align: center;">1.3 V</p>
					Front wiper switch LO	 <p style="text-align: right;">JPMIA0038GB</p> <p style="text-align: center;">1.3 V</p>
					Front washer switch ON	 <p style="text-align: right;">JPMIA0039GB</p> <p style="text-align: center;">1.3 V</p>

BCM (BODY CONTROL MODULE)

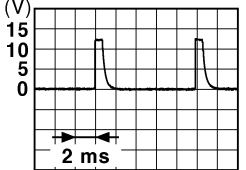
< ECU DIAGNOSIS INFORMATION >

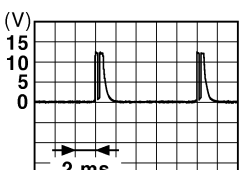
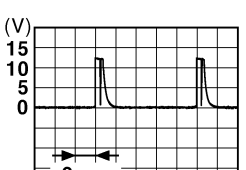
Terminal No. (Wire color)		Description		Condition	Value (Approx.)	
		Signal name	Input/ Output			
+	-					
108 (R)	Ground	Combination switch INPUT 4	Input	Combination switch	All switches OFF (Wiper volume dial 4)	 <p style="text-align: right;">1.4 V</p>
					Lighting switch AUTO (Wiper volume dial 4)	 <p style="text-align: right;">1.3 V</p>
					Lighting switch 1ST (Wiper volume dial 4)	 <p style="text-align: right;">1.3 V</p>
					Any of the conditions below with all switches OFF <ul style="list-style-type: none"> • Wiper volume dial 1 • Wiper volume dial 5 • Wiper volume dial 6 	 <p style="text-align: right;">1.3 V</p>





A
B
C
D
E
F
G
H
I
J
K
L

BCS

N
O
P

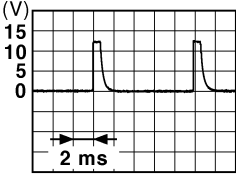
BCM (BODY CONTROL MODULE)

< ECU DIAGNOSIS INFORMATION >

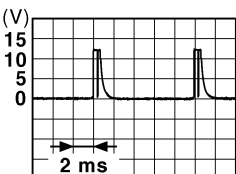
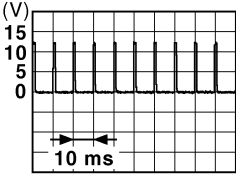
Terminal No. (Wire color)		Description		Condition	Value (Approx.)	
+	-	Signal name	Input/ Output			
109 (W)	Ground	Combination switch INPUT 2	Input	Combination switch (Wiper volume dial 4)	All switches OFF	 <p style="text-align: right;">JPMIA0041GB</p> <p style="text-align: center;">1.4 V</p>
					Lighting switch PASS	 <p style="text-align: right;">JPMIA0037GB</p> <p style="text-align: center;">1.3 V</p>
					Lighting switch 2ND	 <p style="text-align: right;">JPMIA0036GB</p> <p style="text-align: center;">1.3 V</p>
					Front wiper switch INT/ AUTO	 <p style="text-align: right;">JPMIA0038GB</p> <p style="text-align: center;">1.3 V</p>
					Front wiper switch HI	 <p style="text-align: right;">JPMIA0040GB</p> <p style="text-align: center;">1.3 V</p>
110 (G)	Ground	Hazard switch	Input	Hazard switch	ON	0 V
					OFF	 <p style="text-align: right;">JPMIA0012GB</p> <p style="text-align: center;">1.1 V</p>

BCM (BODY CONTROL MODULE)

< ECU DIAGNOSIS INFORMATION >

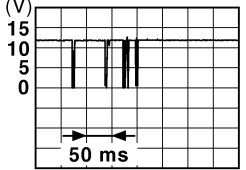
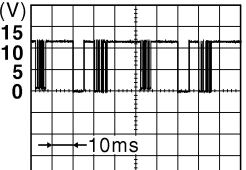
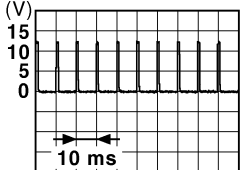
Terminal No. (Wire color)		Description		Condition	Value (Approx.)	
		Signal name	Input/ Output			
+	-					
111 (Y)	Ground	Steering lock unit communication	Input/ Output	Steering lock	LOCK status	12 V
					LOCK or UNLOCK	
					For 15 seconds after UNLOCK	12 V
				15 seconds or later after UNLOCK	0 V	
112 (R)	Ground	Rain sensor serial link	Input/ Output	Ignition switch ON	 8.7 V	
113 (BG)	Ground	Optical sensor	Input	Ignition switch ON	When bright outside of the vehicle	Close to 5 V
					When dark outside of the vehicle	Close to 0 V
114 (P)	Ground	Clutch interlock switch	Input	Clutch interlock switch	OFF (Clutch pedal is not depressed)	0 V
					ON (Clutch pedal is depressed)	Battery voltage
116 (SB)	Ground	Stop lamp switch 1	Input	—	Battery voltage	
118 (BR)	Ground	Stop lamp switch 2 (Without ICC)	Input	Stop lamp switch	OFF (Brake pedal is not depressed)	0 V
					ON (Brake pedal is depressed)	Battery voltage
		Stop lamp switch 2 (With ICC)		Stop lamp switch OFF (Brake pedal is not depressed) and ICC brake hold relay OFF	0 V	
				Stop lamp switch ON (Brake pedal is depressed) or ICC brake hold relay ON	Battery voltage	
119 (SB)	Ground	Driver side door lock assembly (Unlock sensor)	Input	Driver door	LOCK status (Unlock sensor switch OFF)	 1.1 V
					UNLOCK status (Unlock switch sensor ON)	0 V

A
B
C
D
E
F
G
H
I
J
K
L
N
O
P

BCS

BCM (BODY CONTROL MODULE)

< ECU DIAGNOSIS INFORMATION >

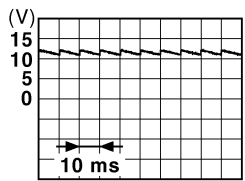
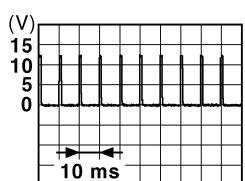
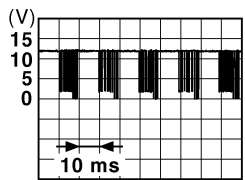
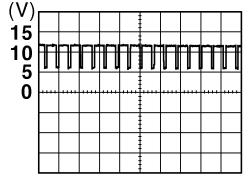
Terminal No. (Wire color)		Description		Condition	Value (Approx.)	
+	-	Signal name	Input/ Output			
121 (G)	Ground	Key slot switch	Input	When the Intelligent Key is inserted into key slot	12 V	
				When the Intelligent Key is not inserted into key slot	0 V	
123 (W)	Ground	IGN feedback	Input	Ignition switch	OFF or ACC	0 V
					ON	Battery voltage
124 (LG)	Ground	Passenger door switch	Input	Passenger door switch	OFF (Door close)	 <small>JPMIA0011GB</small> 11.8 V
					ON (Door open)	0 V
129 (Y)	Ground	Trunk lid opener cancel switch	Input	Trunk lid opener cancel switch	CANCEL	 <small>JPMIA0012GB</small> 1.1 V
					ON	0 V
132 (V)	Ground	Power window switch communication	Input/ Output	Ignition switch ON	 <small>JPMIA0013GB</small> 10.2 V	
					Ignition switch OFF or ACC	12 V
133 (L)	Ground	Push-button ignition switch illumination	Output	Push-button ignition switch illumination	ON (Tail lamps OFF)	9.5 V
					ON (Tail lamps ON)	<p>NOTE: The pulse width of this wave is varied by the illumination brightening/dimming level.</p>  <small>JPMIA0159GB</small>
					OFF	0 V
134 (R)	Ground	LOCK indicator lamp	Output	LOCK indicator lamp	OFF	Battery voltage
					ON	0 V
137 (BG)	Ground	Receiver and sensor ground	Input	Ignition switch ON	0 V	

BCM (BODY CONTROL MODULE)

< ECU DIAGNOSIS INFORMATION >

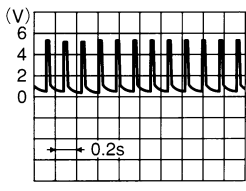
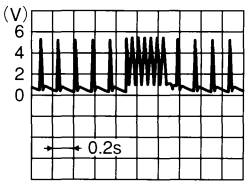
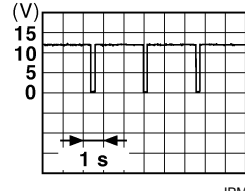
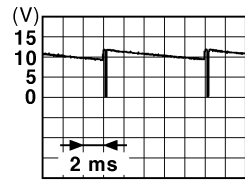
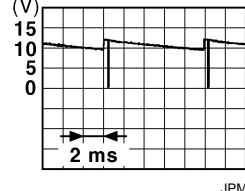
Terminal No. (Wire color)		Description		Condition		Value (Approx.)
		Signal name	Input/ Output			
+	-					
138 (V)	Ground	Receiver and sensor power supply	Output	Ignition switch	OFF	0 V
					ACC or ON	5.0 V
139 (L)	Ground	Tire pressure receiver communication	Input/ Output	Ignition switch ON	Standby state	 OCC3881D
					When receiving the signal from the transmitter	 OCC3880D
140 (Y)	Ground	Selector lever P/N position (A/T models)	Input	Selector lever	P or N position	12 V
					Except P and N positions	0 V
141 (P)	Ground	Security indicator	Output	Security indicator	ON	0 V
					Blinking	 JPMA0014GB
142 (LG)	Ground	Combination switch OUTPUT 5	Output	Combination switch (Wiper volume dial 4)	OFF	12 V
					All switches OFF Lighting switch 1ST Lighting switch HI Lighting switch 2ND Turn signal switch RH	 JPMA0031GB
143 (V)	Ground	Combination switch OUTPUT 1	Output	Combination switch	All switches OFF (Wiper volume dial 4)	0 V
					Front wiper switch HI (Wiper volume dial 4) Any of the conditions below with all switches OFF • Wiper volume dial 1 • Wiper volume dial 2 • Wiper volume dial 3 • Wiper volume dial 6 • Wiper volume dial 7	 JPMA0032GB

A
B
C
D
E
F
G
H
I
J
K
L
N
O
P

BCS

BCM (BODY CONTROL MODULE)

< ECU DIAGNOSIS INFORMATION >

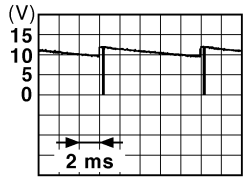
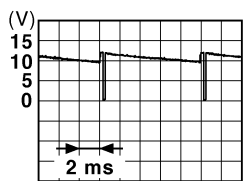
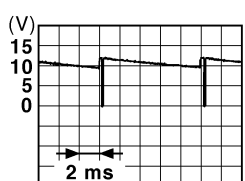
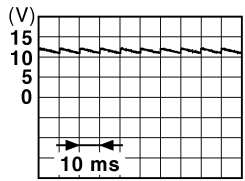
Terminal No. (Wire color)		Description		Condition	Value (Approx.)		
+	-	Signal name	Input/ Output				
144 (G)	Ground	Combination switch OUTPUT 2	Output	Combination switch	All switches OFF (Wiper volume dial 4)	0 V	
					Front washer switch ON (Wiper volume dial 4)		
					Any of the conditions below with all switches OFF		<ul style="list-style-type: none"> • Wiper volume dial 1 • Wiper volume dial 5 • Wiper volume dial 6
10.7 V							
145 (L)	Ground	Combination switch OUTPUT 3	Output	Combination switch (Wiper volume dial 4)	All switches OFF	0 V	
					Front wiper switch INT/ AUTO		
					Front wiper switch LO		
					Lighting switch AUTO		
10.7 V							
146 (SB)	Ground	Combination switch OUTPUT 4	Output	Combination switch (Wiper volume dial 4)	All switches OFF	0 V	
					Front fog lamp switch ON		
					Lighting switch 2ND		
					Lighting switch PASS		
					Turn signal switch LH		
10.7 V							
149 (W)	Ground	Tire pressure warning check switch	Input	—	12 V		
150 (R)	Ground	Driver door switch	Input	Driver door switch	OFF (Door close)		
					ON (Door open)		11.8 V
151 (G)	Ground	Rear window defogger relay control	Output	Rear window defogger	Active	0 V	
					Not activated	Battery voltage	

- *1: A/T models
- *2: M/T models

BCM (BODY CONTROL MODULE)

< ECU DIAGNOSIS INFORMATION >

Wiring Diagram - BCM -

INFOID:000000005656219

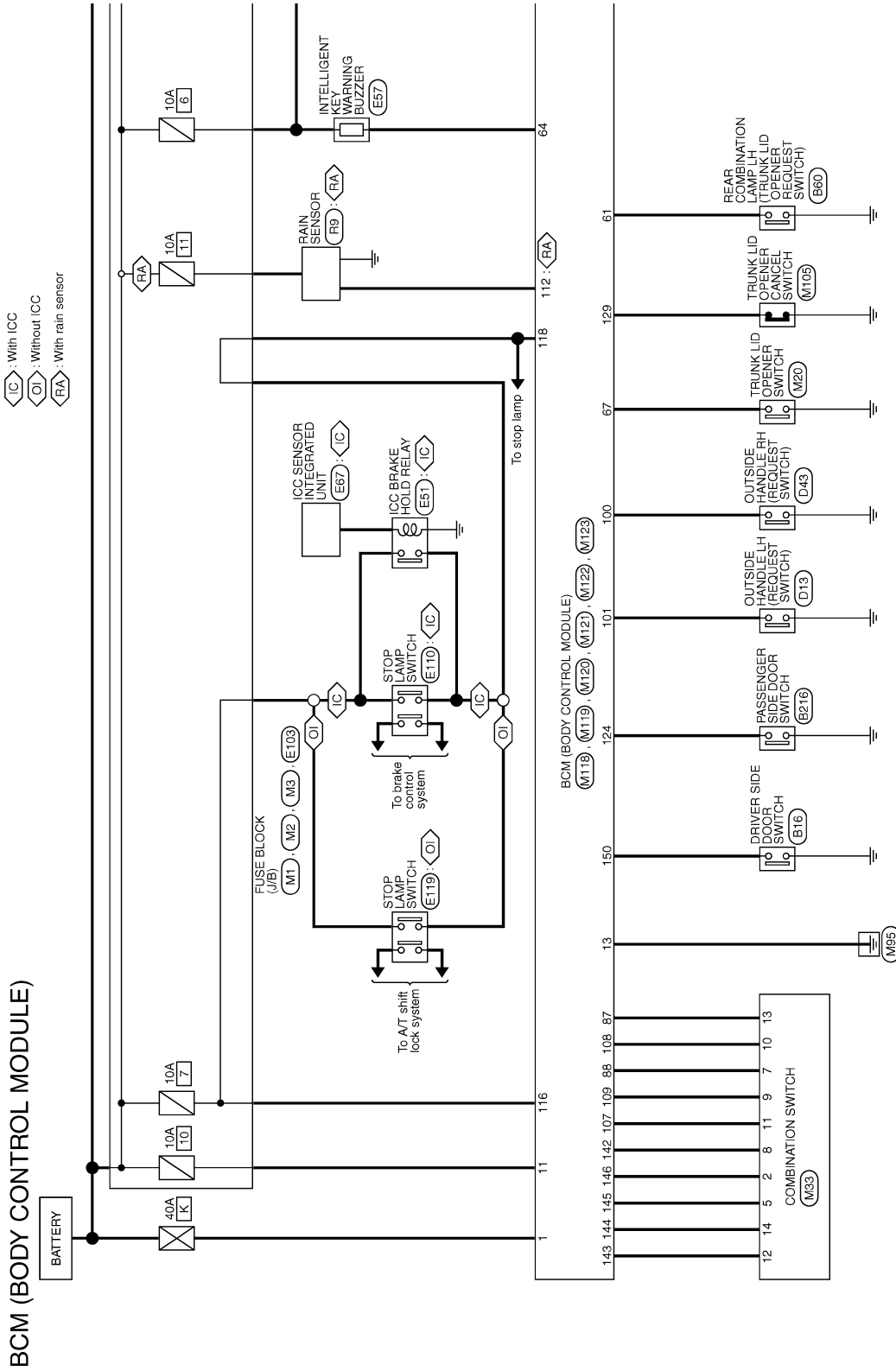

2009/11/05

JCMWM5999GI

A
B
C
D
E
F
G
H
I
J
K
L
N
O
P

BCS

BCM (BODY CONTROL MODULE)

< ECU DIAGNOSIS INFORMATION >

 : With M/T

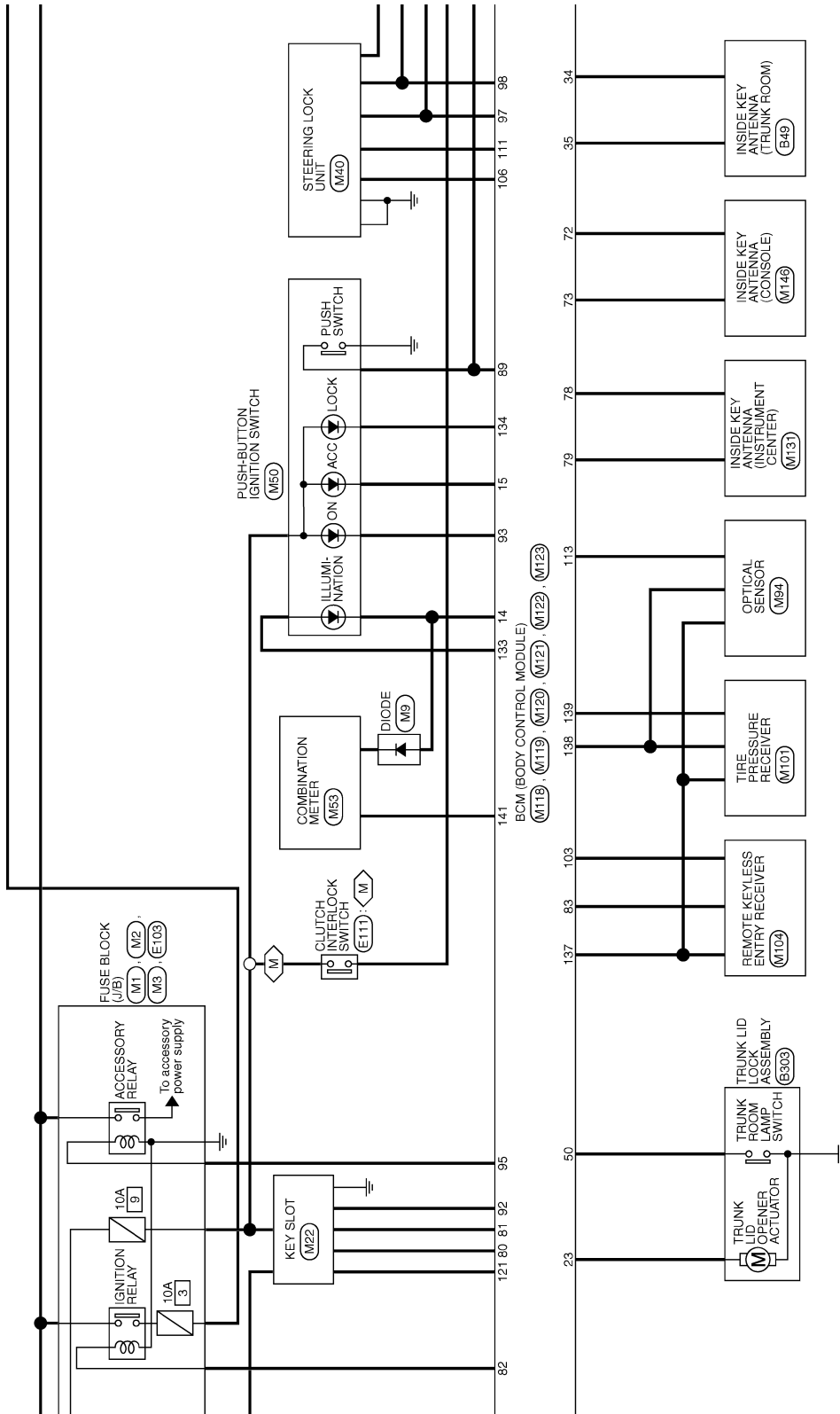

JCMWM6000G

BCM (BODY CONTROL MODULE)

< ECU DIAGNOSIS INFORMATION >

- : With A/T
- : With M/T
- : With sunroof
- : With ICC
- : Without ICC

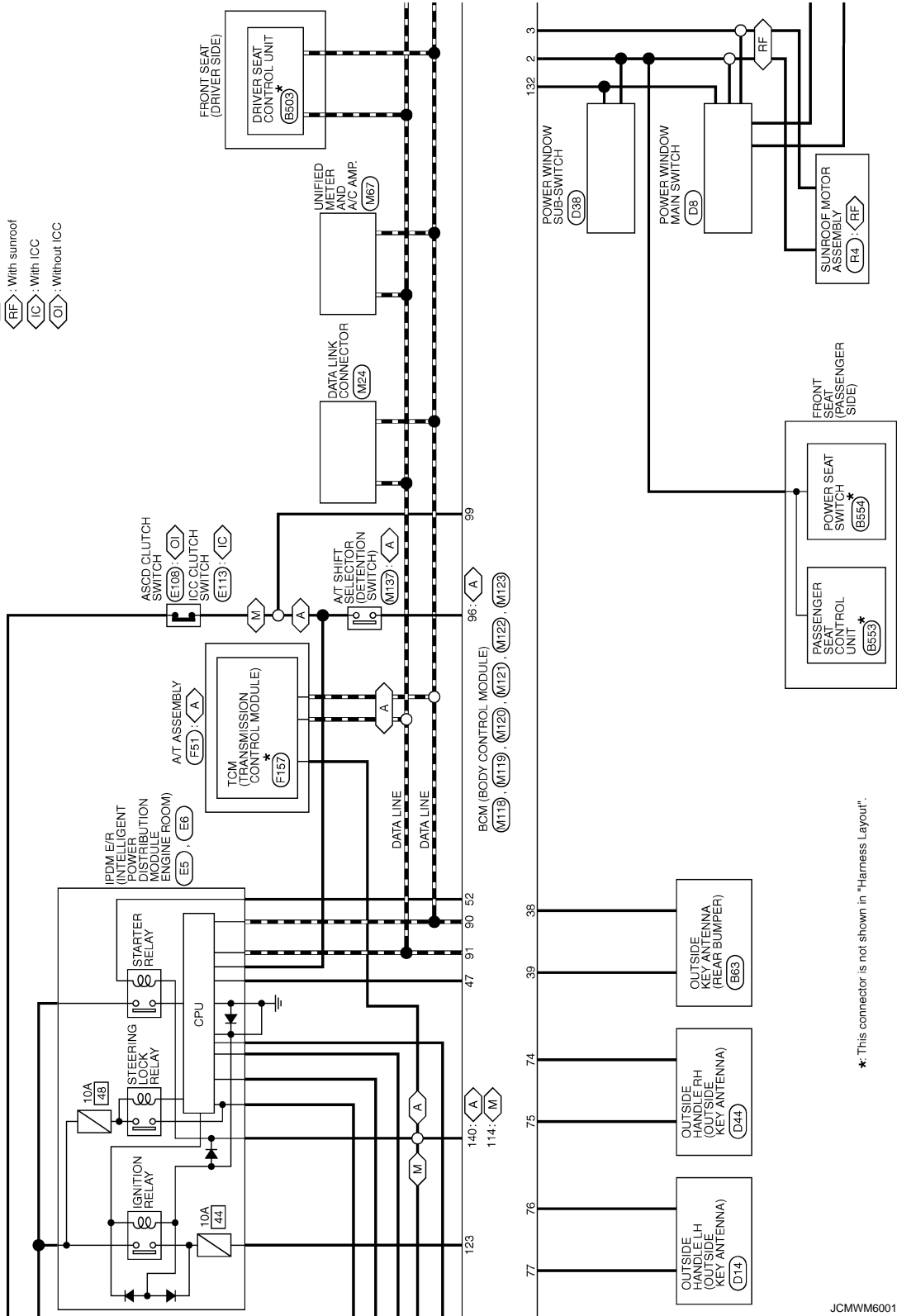

*: This connector is not shown in "Harness Layout".

JCMWM6001G1

A
B
C
D
E
F
G
H
I
J
K
L
BCS
N
O
P

BCM (BODY CONTROL MODULE)

< ECU DIAGNOSIS INFORMATION >

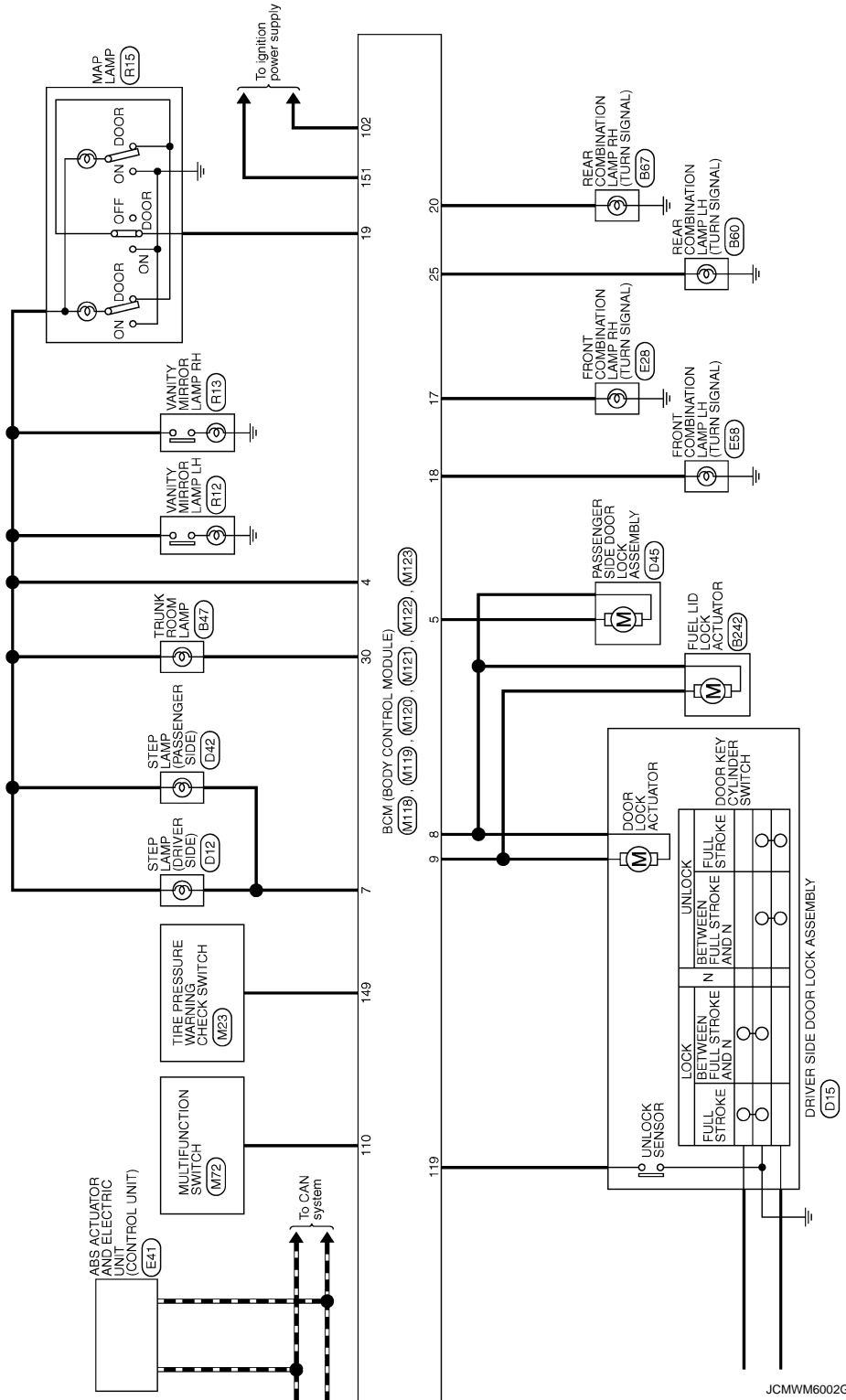

BCM (BODY CONTROL MODULE)

< ECU DIAGNOSIS INFORMATION >

BCM (BODY CONTROL MODULE)

Connector No.	M33
Connector Name	COMBINATION SWITCH
Connector Type	TH16FV-NH

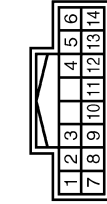

Terminal No.	Color of Wire	Signal Name [Specification]
1	P	ER WASHER (-)
2	SB	OUTPUT 4
3	L	OUTPUT 3
4	B	GND
5	GR	INPUT 3
6	LG	OUTPUT 5
7	W	INPUT 2
8	R	INPUT 4
9	LG	INPUT 1
10	W	INPUT 5
11	Y	OUTPUT 1
12	Y	OUTPUT 2
13	G	GND
14	G	GND

Connector No.	M18
Connector Name	BCM (BODY CONTROL MODULE)
Connector Type	M03FB-LG



Terminal No.	Color of Wire	Signal Name [Specification]
1	L	BAT (E/L)
2	Y	POWER WINDOW POWER SUPPLY (BAT)
3	BG	POWER WINDOW POWER SUPPLY (RAP)

Connector No.	M119
Connector Name	BCM (BODY CONTROL MODULE)
Connector Type	NS16FF-CS

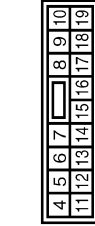

Terminal No.	Color of Wire	Signal Name [Specification]
4	LG	INTERIOR ROOM LAMP POWER SUPPLY
5	P	PASSENGER DOOR UNLOCK OUTPUT
6	SB	STEP LAMP OUTPUT
7	B	ALL DOOR FUEL LID LOCK OUTPUT
8	V	DRIVER DOOR FUEL LID UNLOCK OUTPUT
9	R	BATT (FUSE)
10	B	GND
11	B	GND
12	W	PUSH BUTTON IGNITION SW ILL GND
13	EG	ACC IND
14	W	TURN SIGNAL RH (FRONT)
15	W	TURN SIGNAL LH (FRONT)
16	BG	ROOM LAMP TIMER CONTROL
17	V	GND
18	V	GND
19	V	GND

Connector No.	M120
Connector Name	BCM (BODY CONTROL MODULE)
Connector Type	NS12FFW-CS

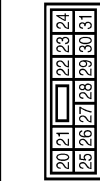

Terminal No.	Color of Wire	Signal Name [Specification]
20	V	TURN SIGNAL RH (REAR)
21	L	TRUNK LID OPEN OUTPUT
22	Y	TURN SIGNAL LH (REAR)
23	P	TRUNK ROOM LAMP
24	P	GND
25	P	GND
26	P	GND
27	P	GND
28	P	GND
29	P	GND
30	P	GND
31	P	GND

Connector No.	M121
Connector Name	BCM (BODY CONTROL MODULE)
Connector Type	TH40FGY-NH

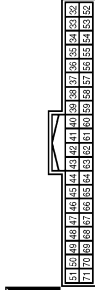

Terminal No.	Color of Wire	Signal Name [Specification]
34	SB	TRUNK ROOM ANT-
35	V	REAR BUMPER ANT-
36	B	REAR BUMPER ANT-
37	W	REAR BUMPER ANT-
38	Y	REAR BUMPER ANT-
39	Y	REAR BUMPER ANT-
40	Y	REAR BUMPER ANT-
41	Y	REAR BUMPER ANT-
42	Y	REAR BUMPER ANT-
43	Y	REAR BUMPER ANT-
44	Y	REAR BUMPER ANT-
45	Y	REAR BUMPER ANT-
46	Y	REAR BUMPER ANT-
47	Y	REAR BUMPER ANT-
48	Y	REAR BUMPER ANT-
49	Y	REAR BUMPER ANT-
50	G	TRUNK ROOM LAMP SW
51	SB	STARTER RELAY CONT
52	SB	TRUNK LID OPENER REQUEST SW
53	P	F-KEY WARN BUZZER (ENG ROOM)
54	P	TRUNK LID OPENER SW
55	P	TRUNK LID OPENER SW
56	P	TRUNK LID OPENER SW
57	P	TRUNK LID OPENER SW
58	P	TRUNK LID OPENER SW
59	P	TRUNK LID OPENER SW
60	P	TRUNK LID OPENER SW
61	P	TRUNK LID OPENER SW
62	P	TRUNK LID OPENER SW
63	P	TRUNK LID OPENER SW
64	P	TRUNK LID OPENER SW
65	P	TRUNK LID OPENER SW
66	P	TRUNK LID OPENER SW
67	P	TRUNK LID OPENER SW

Connector No.	M122
Connector Name	BCM (BODY CONTROL MODULE)
Connector Type	TH40FB-NH

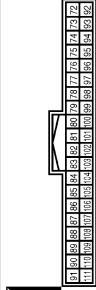

Terminal No.	Color of Wire	Signal Name [Specification]
72	R	ROOM ANT 2-
73	G	ROOM ANT 2+
74	SB	PASSENGER DOOR ANT-
75	BR	PASSENGER DOOR ANT-
76	V	DRIVER DOOR ANT-
77	LG	DRIVER DOOR ANT-
78	Y	ROOM ANT 1-
79	BR	ROOM ANT 1+
80	GR	NATS ANT AMP
81	W	NATS ANT AMP
82	V	IGN RELAY (E/B) CONT
83	Y	KEYLESS ENTRY RECEIVER COMM

87	Y	COMBI SW INPUT 5
88	GR	COMBI SW INPUT 3
89	BR	PUSH SW
90	P	CAN-L
91	L	CAN-H
92	LG	KEY SLOT ILL
93	GR	ON IND
95	BG	ACC RELAY CONT
96	GR	A/T SHIFT SELECTOR POWER SUPPLY
97	L	S/L CONDITION 1
98	BG	S/L CONDITION 2
99	P	SHIFT P (With A/T)
99	R	ICC CLUTCH SW (M/T models with ICC)
99	R	ASCD CLUTCH SW (M/T models without ICC)
100	Y	PASSENGER DOOR REQUEST SW
101	R	DRIVER DOOR REQUEST SW
102	BG	BLOWER FAN MOTOR RELAY CONT
103	LG	KEYLESS ENTRY RECEIVER POWER SUPPLY
106	W	S/L UNIT POWER SUPPLY
107	LG	COMBI SW INPUT 1
108	R	COMBI SW INPUT 4
109	W	COMBI SW INPUT 2
110	G	HAZARD SW
111	Y	S/L UNIT COMM

A
B
C
D
E
F
G
H
I
J
K
L
N
O
P

BCS

BCM (BODY CONTROL MODULE)

< ECU DIAGNOSIS INFORMATION >

BCM (BODY CONTROL MODULE)	
Connector No.	M123
Connector Name	BCM (BODY CONTROL MODULE)
Connector Type	TH40FG-1N1

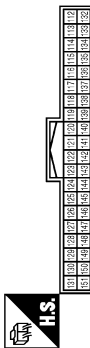

Terminal No.	Color of Wire	Signal Name [Specification]
112	R	RAIN SENSOR SERIAL LINK
113	BG	OPTICAL SENSOR
114	P	CLUTCH INTERLOCK SW
116	SB	STOP LAMP SW 1
118	BR	STOP LAMP SW 2
119	SB	DR DOOR UNLOCK SENSOR
121	G	KEY SLOT SW
123	W	IGN P/B
124	LG	PASSENGER DOOR SW
129	Y	TRUNK LID OPENER CANCEL SW
132	Y	POWER WINDOW SW COMM
133	L	PUSH-BUTTON IGNITION SW ILL POWER
134	R	LOCK IND
137	BG	RECEIVER / SENSOR GND
138	V	RECEIVER / SENSOR POWER SUPPLY
139	L	TIRE PRESSURE RECEIVER COMM
140	Y	SHIFT N/P
141	P	SECURITY INDICATOR
142	LG	COMBI SW OUTPUT 5
143	V	COMBI SW OUTPUT 1
144	G	COMBI SW OUTPUT 2
145	L	COMBI SW OUTPUT 3
146	SB	COMBI SW OUTPUT 4
148	W	TIRE PRESSURE WARN CHECK SW
150	R	DRIVER DOOR SW
151	G	REAR WINDOW DEFROGGER RELAY CONT

JCMWM6004G

INFOID:000000005656220

Fail-safe

FAIL-SAFE CONTROL BY DTC

BCM performs fail-safe control when any DTC are detected.

BCM (BODY CONTROL MODULE)

< ECU DIAGNOSIS INFORMATION >

Display contents of CONSULT	Fail-safe	Cancellation	A
B2013: ID DISCORD BCM-S/L	Inhibit engine cranking	Erase DTC	A
B2014: CHAIN OF S/L-BCM	Inhibit engine cranking	Erase DTC	B
B2190: NATS ANTENNA AMP	Inhibit engine cranking	Erase DTC	B
B2191: DIFFERENCE OF KEY	Inhibit engine cranking	Erase DTC	C
B2192: ID DISCORD BCM-ECM	Inhibit engine cranking	Erase DTC	C
B2193: CHAIN OF BCM-ECM	Inhibit engine cranking	Erase DTC	D
B2195: ANTI-SCANNING	Inhibit engine cranking	Ignition switch ON → OFF	D
B2557: VEHICLE SPEED	Inhibit steering lock	When normal vehicle speed signals are received from ABS actuator and electric unit (control unit) for 500 ms	E
B2560: STARTER CONT RELAY	Inhibit engine cranking	500 ms after the following CAN signal communication status becomes consistent <ul style="list-style-type: none"> • Starter control relay signal • Starter relay status signal 	E
B2601: SHIFT POSITION	Inhibit steering lock	500 ms after the following signal reception status becomes consistent <ul style="list-style-type: none"> • Selector lever P position switch signal • P range signal (CAN) 	F
B2602: SHIFT POSITION	Inhibit steering lock	5 seconds after the following BCM recognition conditions are fulfilled <ul style="list-style-type: none"> • Ignition switch is in the ON position • Selector lever P position switch signal: Except P position (12 V) • Vehicle speed: 4 km/h (2.5 MPH) or more 	G
B2603: SHIFT POSI STATUS	Inhibit steering lock	500 ms after the following BCM recognition conditions are fulfilled <ul style="list-style-type: none"> • Ignition switch is in the ON position • Selector lever P position switch signal: Except P position (12 V) • Selector lever P/N position signal: Except P and N positions (0 V) 	H
B2604: PNP/CLUTCH SW	Inhibit steering lock	500 ms after any of the following BCM recognition conditions are fulfilled <ul style="list-style-type: none"> • Status 1 <ul style="list-style-type: none"> - Ignition switch is in the ON position - Selector lever P/N position signal: P and N position (12 V) - P range signal or N range signal (CAN): ON • Status 2 <ul style="list-style-type: none"> - Ignition switch is in the ON position - Selector lever P/N position signal: Except P and N positions (0 V) - P range signal and N range signal (CAN): OFF 	I
B2605: PNP/CLUTCH SW	Inhibit steering lock	500 ms after any of the following BCM recognition conditions are fulfilled <ul style="list-style-type: none"> • Status 1 <ul style="list-style-type: none"> - Ignition switch is in the ON position - Selector lever P/N position signal: Except P and N positions (0 V) - Interlock/PNP switch signal (CAN): OFF • Status 2 <ul style="list-style-type: none"> - Ignition switch is in the ON position - Selector lever P/N position signal: P or N position (12 V) - PNP switch signal (CAN): ON 	J
B2606: S/L RELAY	Inhibit engine cranking	500 ms after the following CAN signal communication status becomes consistent <ul style="list-style-type: none"> • Steering lock relay signal (Request signal) • Steering lock relay signal (Condition signal) 	K
B2607: S/L RELAY	Inhibit engine cranking	500 ms after the following CAN signal communication status has become consistent <ul style="list-style-type: none"> • Steering lock relay signal (Request signal) • Steering lock relay signal (Condition signal) 	L

BCS

BCM (BODY CONTROL MODULE)

< ECU DIAGNOSIS INFORMATION >

Display contents of CONSULT	Fail-safe	Cancellation
B2608: STARTER RELAY	Inhibit engine cranking	500 ms after the following signal communication status becomes consistent <ul style="list-style-type: none"> • Starter motor relay control signal • Starter relay status signal (CAN)
B2609: S/L STATUS	<ul style="list-style-type: none"> • Inhibit engine cranking • Inhibit steering lock 	When the following steering lock conditions agree <ul style="list-style-type: none"> • BCM steering lock control status • Steering lock condition No. 1 signal status • Steering lock condition No. 2 signal status
B260A: IGNITION RELAY	Inhibit engine cranking	500 ms after the following conditions are fulfilled <ul style="list-style-type: none"> • IGN relay (IPDM E/R) control signal: OFF (12 V) • Ignition ON signal (CAN to IPDM E/R): OFF (Request signal) • Ignition ON signal (CAN from IPDM E/R): OFF (Condition signal)
B260F: ENG STATE SIG LOST	Maintains the power supply position attained at the time of DTC detection	When any of the following conditions are fulfilled <ul style="list-style-type: none"> • Power position changes to ACC • Receives engine status signal (CAN)
B2612: S/L STATUS	<ul style="list-style-type: none"> • Inhibit engine cranking • Inhibit steering lock 	When any of the following conditions are fulfilled <ul style="list-style-type: none"> • Steering lock unit status signal (CAN) is received normally • The BCM steering lock control status matches the steering lock status recognized by the steering lock unit status signal (CAN from IPDM E/R)
B2617: BCM	Inhibit engine cranking	1 second after the starter motor relay control inside BCM becomes normal
B2618: BCM	Inhibit engine cranking	1 second after the ignition relay (IPDM E/R) control inside BCM becomes normal
B2619: BCM	Inhibit engine cranking	1 second after the steering lock unit power supply output control inside BCM becomes normal
B261E: VEHICLE TYPE	Inhibit engine cranking	BCM initialization
B26E8: CLUTCH SW	Inhibit engine cranking	When any of the following BCM recognition conditions are fulfilled <ul style="list-style-type: none"> • Status 1 <ul style="list-style-type: none"> - Clutch switch signal (CAN from ECM): ON - Clutch interlock switch signal: OFF (0 V) • Status 2 <ul style="list-style-type: none"> - Clutch switch signal (CAN from ECM): OFF - Clutch interlock switch signal: ON (Battery voltage)
B26E9: S/L STATUS	<ul style="list-style-type: none"> • Inhibit engine cranking • Inhibit steering lock 	When BCM transmits the LOCK request signal to steering lock unit, and receives LOCK response signal from steering lock unit, the following conditions are fulfilled <ul style="list-style-type: none"> • Steering condition No. 1 signal: LOCK (0 V) • Steering condition No. 2 signal: LOCK (12 V)

DTC Inspection Priority Chart

INFOID:000000005656221

If some DTCs are displayed at the same time, perform inspections one by one based on the following priority chart.

Priority	DTC
1	B2562: LOW VOLTAGE
2	<ul style="list-style-type: none"> • U1000: CAN COMM • U1010: CONTROL UNIT(CAN)
3	<ul style="list-style-type: none"> • B2190: NATS ANTENNA AMP • B2191: DIFFERENCE OF KEY • B2192: ID DISCORD BCM-ECM • B2193: CHAIN OF BCM-ECM • B2195: ANTI-SCANNING

BCM (BODY CONTROL MODULE)

< ECU DIAGNOSIS INFORMATION >

Priority	DTC	A
4	<ul style="list-style-type: none"> • B2013: ID DISCORD BCM-S/L • B2014: CHAIN OF S/L-BCM • B2553: IGNITION RELAY • B2555: STOP LAMP • B2556: PUSH-BTN IGN SW • B2557: VEHICLE SPEED • B2560: STARTER CONT RELAY • B2601: SHIFT POSITION • B2602: SHIFT POSITION • B2603: SHIFT POSI STATUS • B2604: PNP/CLUTCH SW • B2605: PNP/CLUTCH SW • B2606: S/L RELAY • B2607: S/L RELAY • B2608: STARTER RELAY • B2609: S/L STATUS • B260A: IGNITION RELAY • B260B: STEERING LOCK UNIT • B260C: STEERING LOCK UNIT • B260D: STEERING LOCK UNIT • B260F: ENG STATE SIG LOST • B2612: S/L STATUS • B2614: BCM • B2615: BCM • B2616: BCM • B2617: BCM • B2618: BCM • B2619: BCM • B261A: PUSH-BTN IGN SW • B261E: VEHICLE TYPE • B26E8: CLUTCH SW • B26E9: S/L STATUS • B26EA: KEY REGISTRATION • C1729: VHCL SPEED SIG ERR • U0415: VEHICLE SPEED 	B C D E F G H I J
5	<ul style="list-style-type: none"> • C1704: LOW PRESSURE FL • C1705: LOW PRESSURE FR • C1706: LOW PRESSURE RR • C1707: LOW PRESSURE RL • C1708: [NO DATA] FL • C1709: [NO DATA] FR • C1710: [NO DATA] RR • C1711: [NO DATA] RL • C1716: [PRESSDATA ERR] FL • C1717: [PRESSDATA ERR] FR • C1718: [PRESSDATA ERR] RR • C1719: [PRESSDATA ERR] RL • C1734: CONTROL UNIT 	K L
6	<ul style="list-style-type: none"> • B2621: INSIDE ANTENNA • B2622: INSIDE ANTENNA • B2623: INSIDE ANTENNA 	N

BCS

DTC Index

INFOID:000000005656222

NOTE:

The details of time display are as follows.

- CRNT: A malfunction is detected now.
- PAST: A malfunction was detected in the past.

IGN counter is displayed on Freeze Frame Data. For details of Freeze Frame Data, refer to [BCS-14. "COMMON ITEM : CONSULT-III Function \(BCM - COMMON ITEM\)".](#)

BCM (BODY CONTROL MODULE)

< ECU DIAGNOSIS INFORMATION >

CONSULT display	Fail-safe	Freeze Frame Data •Vehicle Speed •Odo/Trip Meter •Vehicle condition	Intelligent Key warning lamp ON	Tire pressure monitor warning lamp ON	Refer- ence page
No DTC is detected. further testing may be required.	—	—	—	—	—
U1000: CAN COMM	—	—	—	—	BCS-33
U1010: CONTROL UNIT(CAN)	—	—	—	—	BCS-34
U0415: VEHICLE SPEED	—	—	—	—	BCS-35
B2013: ID DISCORD BCM-S/L	×	×	—	—	SEC-55
B2014: CHAIN OF S/L-BCM	×	×	—	—	SEC-56
B2190: NATS ANTENNA AMP	×	—	—	—	SEC-47
B2191: DIFFERENCE OF KEY	×	—	—	—	SEC-50
B2192: ID DISCORD BCM-ECM	×	—	—	—	SEC-51
B2193: CHAIN OF BCM-ECM	×	—	—	—	SEC-53
B2195: ANTI-SCANNING	×	—	—	—	SEC-54
B2553: IGNITION RELAY	—	×	—	—	PCS-48
B2555: STOP LAMP	—	×	—	—	SEC-59
B2556: PUSH-BTN IGN SW	—	×	×	—	SEC-61
B2557: VEHICLE SPEED	×	×	×	—	SEC-63
B2560: STARTER CONT RELAY	×	×	×	—	SEC-64
B2562: LOW VOLTAGE	—	×	—	—	BCS-36
B2601: SHIFT POSITION	×	×	×	—	SEC-65
B2602: SHIFT POSITION	×	×	×	—	SEC-68
B2603: SHIFT POSI STATUS	×	×	×	—	SEC-70
B2604: PNP/CLUTCH SW	×	×	×	—	SEC-73
B2605: PNP/CLUTCH SW	×	×	×	—	SEC-75
B2606: S/L RELAY	×	×	×	—	SEC-77
B2607: S/L RELAY	×	×	×	—	SEC-78
B2608: STARTER RELAY	×	×	×	—	SEC-80
B2609: S/L STATUS	×	×	×	—	SEC-82
B260A: IGNITION RELAY	×	×	×	—	PCS-50
B260B: STEERING LOCK UNIT	—	×	×	—	SEC-86
B260C: STEERING LOCK UNIT	—	×	×	—	SEC-87
B260D: STEERING LOCK UNIT	—	×	×	—	SEC-88
B260F: ENG STATE SIG LOST	×	×	×	—	SEC-89
B2612: S/L STATUS	×	×	×	—	SEC-94
B2614: BCM	—	×	×	—	PCS-52
B2615: BCM	—	×	×	—	PCS-54
B2616: BCM	—	×	×	—	PCS-56
B2617: BCM	×	×	×	—	SEC-98
B2618: BCM	×	×	×	—	PCS-58
B2619: BCM	×	×	×	—	SEC-100
B261A: PUSH-BTN IGN SW	—	×	×	—	PCS-59
B261E: VEHICLE TYPE	×	×	× (Turn ON for 15 seconds)	—	SEC-101

BCM (BODY CONTROL MODULE)

< ECU DIAGNOSIS INFORMATION >

CONSULT display	Fail-safe	Freeze Frame Data •Vehicle Speed •Odo/Trip Meter •Vehicle condition	Intelligent Key warning lamp ON	Tire pressure monitor warning lamp ON	Refer- ence page	A
B2621: INSIDE ANTENNA	—	×	—	—	DLK-55	B
B2622: INSIDE ANTENNA	—	×	—	—	DLK-57	
B2623: INSIDE ANTENNA	—	×	—	—	DLK-59	
B26E8: CLUTCH SW	×	×	×	—	SEC-90	C
B26E9: S/L STATUS	×	×	× (Turn ON for 15 seconds)	—	SEC-92	
B26EA: KEY REGISTRATION	—	×	× (Turn ON for 15 seconds)	—	SEC-93	D
C1704: LOW PRESSURE FL	—	—	—	×	WT-26	E
C1705: LOW PRESSURE FR	—	—	—	×		
C1706: LOW PRESSURE RR	—	—	—	×		
C1707: LOW PRESSURE RL	—	—	—	×		F
C1708: [NO DATA] FL	—	—	—	×	WT-28	
C1709: [NO DATA] FR	—	—	—	×		
C1710: [NO DATA] RR	—	—	—	×		G
C1711: [NO DATA] RL	—	—	—	×		
C1716: [PRESSDATA ERR] FL	—	—	—	×	WT-31	H
C1717: [PRESSDATA ERR] FR	—	—	—	×		
C1718: [PRESSDATA ERR] RR	—	—	—	×		
C1719: [PRESSDATA ERR] RL	—	—	—	×		I
C1729: VHCL SPEED SIG ERR	—	—	—	×	WT-33	
C1734: CONTROL UNIT	—	—	—	×	WT-35	J

BCS

N

O

P

COMBINATION SWITCH SYSTEM SYMPTOMS

< SYMPTOM DIAGNOSIS >

SYMPTOM DIAGNOSIS

COMBINATION SWITCH SYSTEM SYMPTOMS

Symptom Table

INFOID:000000005656223

1. Perform "Data Monitor" of CONSULT-III to check for any malfunctioning item.
2. Check the malfunction combinations.

Malfunction item: ×

Malfunction combination	Data monitor item													
	FR WIPER HI	FR WIPER LOW	FR WASHER SW	FR WIPER INT	INT VOLUME	TURN SIGNAL R	TURN SIGNAL L	TAIL LAMP SW	HI BEAM SW	HEAD LAMP SW 1	HEAD LAMP SW 2	PASSING SW	AUTO LIGHT SW	FR FOG SW
A		×	×			×	×							
B	×			×						×		×		
C					×				×		×			
D					×			×					×	
E					×									×
F	×				×									
G			×		×									
H		×		×									×	
I							×				×	×		×
J						×		×	×	×				
K	All Items													
L	If only one item is detected or the item is not applicable to the combinations A to K													

3. Identify the malfunctioning part from the agreed combination and repair or replace the part.

Malfunction combination	Malfunctioning part	Repair or replace
A	Combination switch INPUT 1 circuit	Inspect the combination switch input circuit applicable to the malfunctioning part. Refer to BCS-38, "Diagnosis Procedure" .
B	Combination switch INPUT 2 circuit	
C	Combination switch INPUT 3 circuit	
D	Combination switch INPUT 4 circuit	
E	Combination switch INPUT 5 circuit	
F	Combination switch OUTPUT 1 circuit	Inspect the combination switch output circuit applicable to the malfunctioning part. Refer to BCS-40, "Diagnosis Procedure" .
G	Combination switch OUTPUT 2 circuit	
H	Combination switch OUTPUT 3 circuit	
I	Combination switch OUTPUT 4 circuit	
J	Combination switch OUTPUT 5 circuit	
K	BCM	Replace BCM. Refer to BCS-78, "Exploded View"
L	Combination switch	Replace the combination switch.

PRECAUTIONS

< PRECAUTION >

PRECAUTION

PRECAUTIONS

Precaution for Supplemental Restraint System (SRS) "AIR BAG" and "SEAT BELT PRE-TENSIONER"

INFOID:000000005656224

The Supplemental Restraint System such as "AIR BAG" and "SEAT BELT PRE-TENSIONER", used along with a front seat belt, helps to reduce the risk or severity of injury to the driver and front passenger for certain types of collision. This system includes seat belt switch inputs and dual stage front air bag modules. The SRS system uses the seat belt switches to determine the front air bag deployment, and may only deploy one front air bag, depending on the severity of a collision and whether the front occupants are belted or unbelted. Information necessary to service the system safely is included in the "SRS AIR BAG" and "SEAT BELT" of this Service Manual.

WARNING:

- To avoid rendering the SRS inoperative, which could increase the risk of personal injury or death in the event of a collision which would result in air bag inflation, all maintenance must be performed by an authorized NISSAN/INFINITI dealer.
- Improper maintenance, including incorrect removal and installation of the SRS, can lead to personal injury caused by unintentional activation of the system. For removal of Spiral Cable and Air Bag Module, see the "SRS AIR BAG".
- Do not use electrical test equipment on any circuit related to the SRS unless instructed to in this Service Manual. SRS wiring harnesses can be identified by yellow and/or orange harnesses or harness connectors.

PRECAUTIONS WHEN USING POWER TOOLS (AIR OR ELECTRIC) AND HAMMERS

WARNING:

- When working near the Air Bag Diagnosis Sensor Unit or other Air Bag System sensors with the ignition ON or engine running, DO NOT use air or electric power tools or strike near the sensor(s) with a hammer. Heavy vibration could activate the sensor(s) and deploy the air bag(s), possibly causing serious injury.
- When using air or electric power tools or hammers, always switch the ignition OFF, disconnect the battery, and wait at least 3 minutes before performing any service.

Precaution for Battery Service

INFOID:000000005656225

Before disconnecting the battery, lower both the driver and passenger windows. This will prevent any interference between the window edge and the vehicle when the door is opened/closed. During normal operation, the window slightly raises and lowers automatically to prevent any window to vehicle interference. The automatic window function will not work with the battery disconnected.

A
B
C
D
E
F
G
H
I
J
K
L
N
O
P

BCS

BCM (BODY CONTROL MODULE)

< REMOVAL AND INSTALLATION >

REMOVAL AND INSTALLATION

BCM (BODY CONTROL MODULE)

Exploded View

INFOID:000000005656226

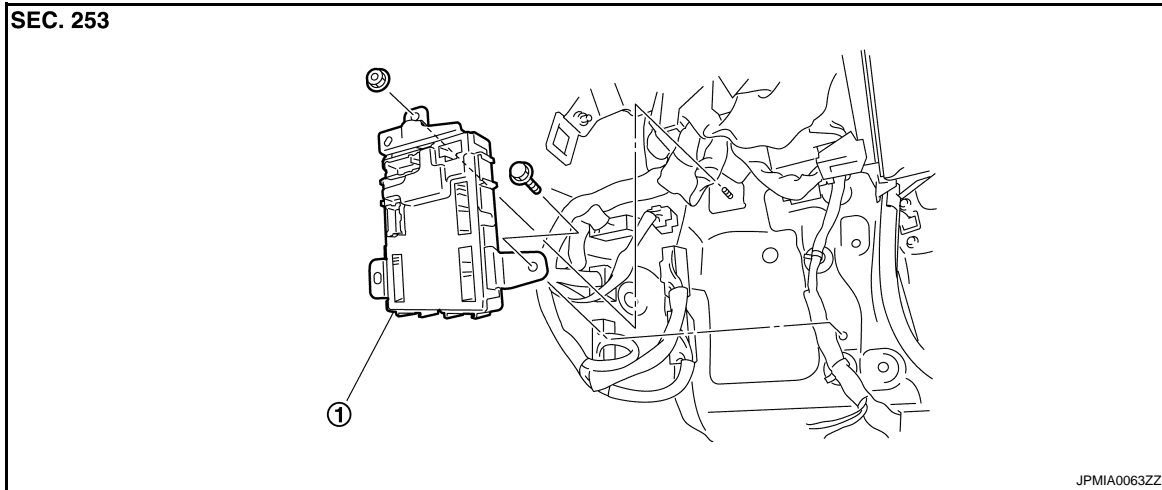

1. BCM

Removal and Installation

INFOID:000000005656227

REMOVAL

1. Remove dash side finisher (passenger side). Refer to [INT-15. "Exploded View"](#).
2. Remove bolt and nut.
3. Remove BCM and disconnect the connector.

INSTALLATION

Install in the reverse order of removal.

COMBINATION SWITCH

< REMOVAL AND INSTALLATION >

COMBINATION SWITCH

Exploded View

INFOID:000000005656228

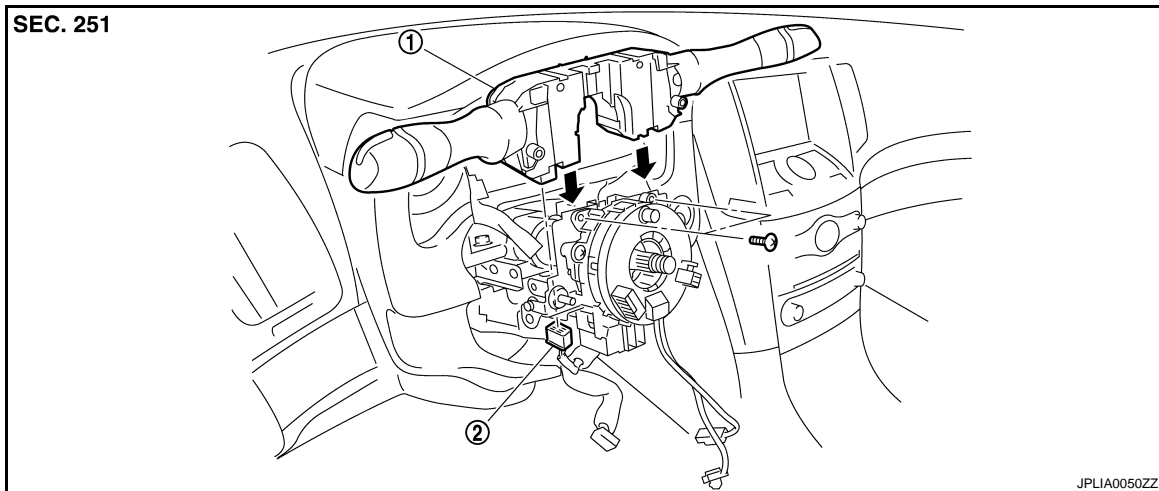

1. Combination switch

2. Combination switch connector

Removal and Installation

INFOID:000000005656229

REMOVAL

1. Remove steering column cover. Refer to [IP-12. "A/T MODELS : Exploded View"](#) (A/T models), [IP-22. "M/T MODELS : Exploded View"](#) (M/T models).
2. Remove screws.
3. Disconnect the connector.
4. Pull up the combination switch to remove it.

INSTALLATION

Install in the reverse order of removal.

A
B
C
D
E
F
G
H
I
J
K
L

BCS